

DELABIE

Accessibility and Independence
Hygienic Accessories for Public
and Commercial Places



CONTACTS

HEAD OFFICE & PRODUCTION SITE

18, rue du Maréchal Foch
80130 Friville
FRANCE

delabie.com

EXPORT

Tel. +33 (0)3 22 60 22 72
Fax +33 (0)3 22 60 22 82
export@delabie.fr

QUOTES

Tel. +33 (0)3 22 60 22 72
Fax +33 (0)3 22 60 22 82
export.quotes@delabie.fr

TECHNICAL SUPPORT

Tel. +33 (0)3 22 60 22 74
Fax +33 (0)3 22 30 31 07
sav@delabie.fr

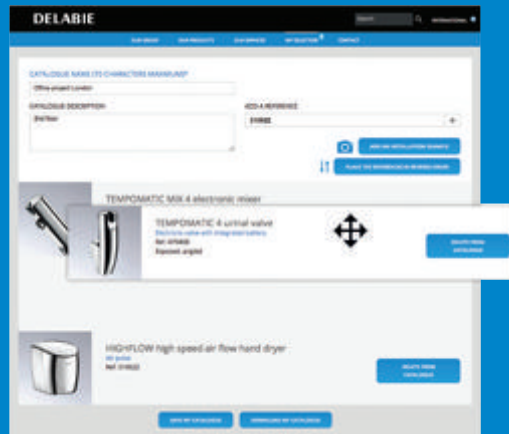

CREATE A PERSONALISED CATALOGUE

Create your own catalogue using your own product selection.

You can personalise it by giving it a project name and description, by choosing the order for the products to appear and by adding lifestyle images.

This catalogue will then be available in **Word**, **PDF** and **Excel** formats.



DATASHARE: ALL THE DOCUMENTS ARE FREELY AVAILABLE

Datashare is DELABIE's platform to download files.

There is no need to sign-in.

Product files, technical descriptions, photos, line drawings, BIM and AutoCAD files, installation guides and certificates are all available online.

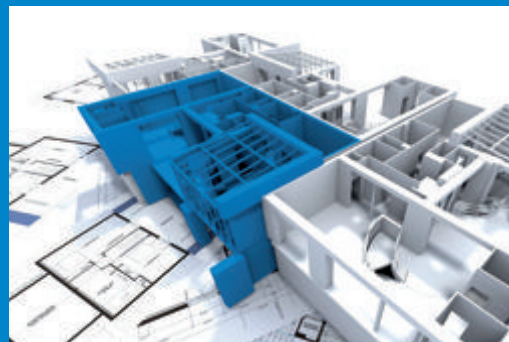

BIM: DELABIE'S CORE PRODUCTS ARE NOW AVAILABLE

To meet the requirements of BIM technology, DELABIE has modelled its core products.

Available in 2 formats - **REVIT** and **IFC**, the files can be downloaded via the relevant product data sheet or via datashare.

The list of references available in BIM format is available in **Our Services - BIM Files**.



Certification
ISO 9001: 2015
quality management
systems

ACS

Certificate of Sanitary Conformity.
All DELABIE products conform to the CPDW* directive modified 29/05/1997, and the French Ministry of Health circular DGS/SD7A2002 no. 571 dated 25/11/2002.

* Construction Products in Contact with Drinking Water (European Commission).



SUITABLE FOR TABLETS AND SMARTPHONES

DELABIE



WCs.....	6
WASHBASINS.....	14
BATHROOMS.....	35
GRAB BARS.....	44
SHOWERS.....	46
ECONOMY RANGE.....	50

**HYGIENIC
ACCESSORIES
FOR PUBLIC
AND COMMERCIAL
PLACES**
3



SHOWER SEATS.....	60
GRAB BARS & DROP-DOWN SUPPORT RAILS.....	62
SHOWER GRAB BARS.....	67
ACCESSORIES.....	74

**ACCESSIBILITY
BE-LINE® RANGE**
53

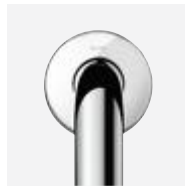

SHOWER SEATS.....	81
GRAB BARS & DROP-DOWN SUPPORT RAILS.....	86
SHOWER GRAB BARS.....	100
ACCESSORIES.....	110
STAINLESS STEEL SANITARY WARE.....	116

**ACCESSIBILITY
STAINLESS STEEL
RANGE**
77

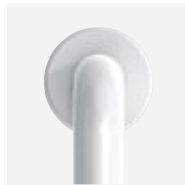

SHOWER SEATS.....	123
GRAB BARS.....	126
DROP-DOWN SUPPORT RAILS.....	130
SHOWER GRAB BARS.....	132
ACCESSORIES.....	142

**ACCESSIBILITY
NYLON RANGE**
119



SEATS & STOOL.....	152
WHITE BASIC GRAB BARS.....	154
SATIN FINISH BASIC GRAB BARS.....	157
ECO GRAB BARS.....	158

**ACCESSIBILITY
BASIC & ECO
RANGES**
151



DOC M PACKS.....	162
DOC M PRODUCTS.....	166
DOC M SPACE GUIDES.....	168

**ACCESSIBILITY
DOC M**
161



ACCESSIBILITY - INDEPENDENCE INSTALLATION ADVICE.....	171
--	-----

**SPACE
GUIDES**
171

REFERENCES INDEX.....	178
-----------------------	-----

INDEX
178



BAILA floor-standing washbasin **120170** - TEMPOMATIC 4 electronic tap **443506** - Wall-mounted liquid soap dispenser **510580**
Recessed combi paper towel dispenser / bin / hand dryer **510716S**

Hygienic accessories for public and commercial places

WCs
6



WASHBASINS
14



BATHROOMS
35



GRAB BARS
44



SHOWERS
46



ECONOMY RANGE
50





MAXIMUM HYGIENE

Stainless Steel: a material that limits bacterial proliferation

The majority of DELABIE's accessories are made from bacteriostatic 304 stainless steel. With this type of stainless steel, a thin, invisible protective layer forms continuously when in contact with air or water. Even if the surface is damaged mechanically, the **stainless steel is protected against corrosion**. The surface remains bright, hard and smooth, preventing bacteria from easily adhering to the surface. Bacterial development is therefore slower compared to other materials. Studies have regularly proven the aseptic qualities of stainless steel.

It is a noble metal alloy ideally suited to environments that demand high standards of hygiene (for example hospitals, retirement homes, schools, canteens, public washrooms, etc.).

Bright polished finish and satin finish: cleaning is easy and sustainable

Using surfaces that are easy to clean and disinfect reduces the spread of bacteria. DELABIE's bright polished finish and polished satin finish provide the accessories with a uniform, non-porous surface. They are easy to clean and require less cleaning product. **Bacterial retention after cleaning is extremely low**, up to 20 times less than for other materials such as glass or plastic.

Studies show that after several cycles of daily soiling and cleaning, polished stainless steel retains less dirt and fewer residual bacteria than copper which also has bactericidal properties. Copper surfaces degrade over time, making them more difficult to clean. Polished stainless steel provides better hygiene by facilitating sustainable cleaning.

Hygiene-friendly design

DELABIE's accessories are designed to meet the obvious and essential principle of hygiene i.e. frequent cleaning. One-piece covers with **fewer niches where bacteria can develop** and soap tanks that prevent the soap from stagnating both contribute to effective cleaning and good hygiene.

MAXIMUM ENDURANCE

High resistance to vandalism

DELABIE's hygienic accessories generally have thicker metal than most products available on the market. This **robust design** offers a high level of resistance to vandalism, appropriate for places subject to intensive use.

To prevent theft, very common in public facilities, a large number of DELABIE's hygienic accessories feature concealed fixings and/or locks with a key. The option to use the **standard DELABIE key** for the majority of DELABIE's products with locks, makes servicing them easy for maintenance staff.

Suitable for intensive use

All DELABIE's products undergo performance tests under extreme conditions. They are **specifically designed for intensive use** in all types of highly frequented public and commercial places.

AND ALSO...

Three finishes

DELABIE's hygienic accessories are available in three finishes to match most styles and types of materials: bright polished stainless steel, polished satin stainless steel and white powder-coated finishes.

Complete range

DELABIE's range provides solutions for a whole variety of different installations such as bathrooms, washrooms, en suites, etc. The quality image of stainless steel associated with the sleek design of DELABIE's hygienic accessories make them the perfect complement to DELABIE's other ranges.

100% recyclable

Stainless steel is 100% recyclable, contributing to sustainable development and protecting the environment. DELABIE's stainless steel products contain 50-65% recycled stainless steel.



Twin toilet roll holder

304 stainless steel



- **Bacteriostatic 304 stainless steel.**
- For two toilet rolls.
- Tube Ø 20mm, 1mm thick.
- **Concealed fixings.**

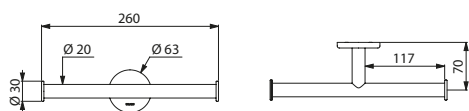

510082

Twin toilet roll holder	
Bright polished 304 stainless steel	510082P
Polished satin 304 stainless steel	510082S
White powder-coated 304 stainless steel	510082W

U-shaped toilet roll holder

304 stainless steel



- **Bacteriostatic 304 stainless steel.**
- Tube Ø 20mm, 1mm thick.
- **Concealed fixings.**

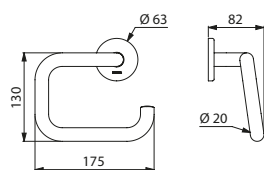

4081

U-shaped toilet roll holder	
Bright polished 304 stainless steel	4081P
Polished satin 304 stainless steel	4081S
White powder-coated 304 stainless steel	4081EW

Toilet roll holder

Or for spares, 304 stainless steel



- **Bacteriostatic 304 stainless steel.**
- Can be installed horizontally for **main use**, or vertically as a **spare toilet roll holder**.
- Tube Ø 20mm, 1mm thick.
- **Concealed fixings.**

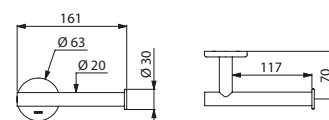

510083

Toilet roll holder	
Bright polished 304 stainless steel	510083P
Polished satin 304 stainless steel	510083S
White powder 304 stainless steel	510083W

U-shaped toilet roll holder

Nylon



- **High-strength polyamide (Nylon).**
- Tube Ø 20mm.
- **Concealed fixings.**

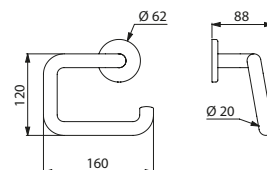

4081N

U-shaped toilet roll holder	
HR Nylon bright white	4081N

Toilet roll holder

For spares, 304 stainless steel

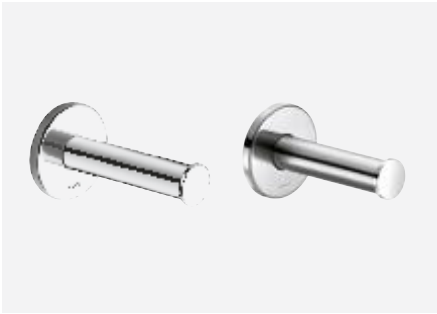

- **Bacteriostatic 304 stainless steel.**
- Tube Ø 25mm, 1.2mm thick.
- **Concealed fixings.**

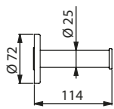

4070

Spare toilet roll holder	
Bright polished 304 stainless steel	4070P
Polished satin 304 stainless steel	4070S

Toilet roll holder with one-piece cover

304 stainless steel, anti-theft



- **Bacteriostatic 304 stainless steel.**
- **One-piece hinged cover** for easy maintenance and better hygiene.
- Anti-theft, unbreakable, integral polycarbonate spindle.
- **Concealed fixings.**
- Dimensions: 119 × 140 × 80mm.

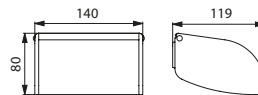

566/510567/3565

Toilet roll holder with one-piece cover	
Bright polished 304 stainless steel	566
Polished satin 304 stainless steel	510567
White powder-coated 304 stainless steel	3565

Toilet roll holder

For spares, Nylon



- **High-strength polyamide (Nylon).**
- Tube Ø 32mm.
- **Concealed fixings.**

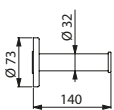

4070N

Spare toilet roll holder HR Nylon bright white	4070N
---	--------------

Toilet paper dispenser for 2 rolls

304 stainless steel



- **Vandal-resistant robust model.**
- **Bacteriostatic 304 stainless steel.**
- 1 spare roll.
- With lock and **standard DELABIE key.**
- Level control.
- Stainless steel thickness: 1mm.
- Dimensions: 130 × 120 × 260mm.

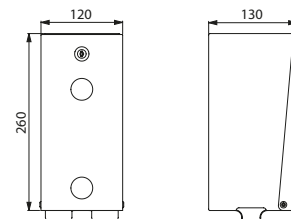

1660/1661

Toilet paper dispenser for 2 rolls	
Bright polished 304 stainless steel	1660
Polished satin 304 stainless steel	1660S
White powder-coated 304 stainless steel	1661



Wall-hung S21 S WC pan **110310** - TEMPOFIX 3 frame system with TEMPOFLUX 2 direct flush time flow valve **578305DE-578222** - Toilet brush set **4051S**
Jumbo toilet paper dispenser **2912** - Coat hook **4043P** - CANAL wash trough **120280** - TEMPOSOFT 2 time flow tap **741550** - Soap dispenser **510582**

Large toilet paper dispenser

For 400m rolls



- **Model for 400m rolls.**
- **One-piece hinged cover** for easy maintenance and better hygiene.
- With lock and **standard DELABIE key.**
- **With back-piece:** protects the paper from wall imperfections, damp and dust.
- Level control.
- Dimensions: Ø 305mm, depth 135mm.

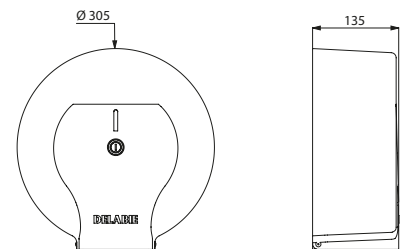

2911/2912/2910

Large toilet paper dispenser for 400m rolls	
Bright polished 304 stainless steel	2911
Polished satin 304 stainless steel	2912
White lacquered steel	2910

Large toilet paper dispenser

For 200m rolls



- **Model for 200m rolls.**
- **One-piece hinged cover** for easy maintenance and better hygiene.
- With lock and **standard DELABIE key.**
- **With back-piece:** protects the paper from wall imperfections, damp and dust.
- Level control.
- Dimensions: Ø 225mm, depth 125mm.

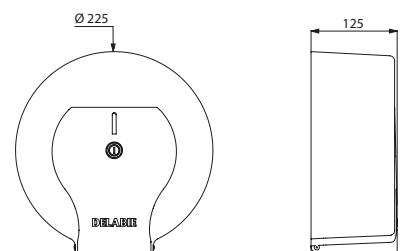

2901/2902/2900

Large toilet paper dispenser for 200m rolls	
Bright polished 304 stainless steel	2901
Polished satin 304 stainless steel	2902
White lacquered steel	2900

Toilet brush set without lid

With anti-theft lock



Bright polished 304 stainless steel



Polished satin 304 stainless steel



White powder-coated 304 stainless steel

- **Robust model.**
- **Bacteriostatic 304 stainless steel.**
- Wall-mounted or floor-standing.
- Easy to clean: plastic bowl can be removed from above.
- **Plastic bowl with reservoir:** prevents toilet brush sitting in residual water and reduces the risk of splashing when next used.
- **Anti-theft lock** (wall-mounted model).
- Stainless steel thickness: 1mm body.
- Dimensions: Ø 90 × 330mm.

Wall-mounted toilet brush set without lid - Anti-theft lock	
Bright polished 304 stainless steel	4048P
Polished satin 304 stainless steel	4048S
White powder-coated 304 stainless steel	4048EW
Floor-standing toilet brush set without lid	
Bright polished 304 stainless steel	4049P
Polished satin 304 stainless steel	4049S
White powder-coated 304 stainless steel	4049EW

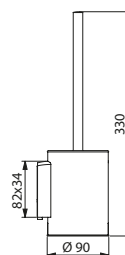

4048

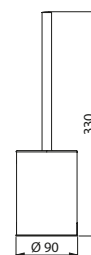

4049

Toilet brush set with lid

With anti-theft lock



Bright polished 304 stainless steel



Polished satin 304 stainless steel



White powder-coated 304 stainless steel

- **Robust model.**
- **Bacteriostatic 304 stainless steel.**
- Wall-mounted or floor-standing.
- Easy to clean: plastic bowl can be removed from above.
- **Plastic bowl with reservoir:** prevents toilet brush sitting in residual water and reduces the risk of splashing when next used.
- Toilet brush **automatically centres itself** in the holder.
- **Anti-theft lock** (wall-mounted model).
- Stainless steel thickness: 1mm body.
- Dimensions: Ø 90 × 410mm.

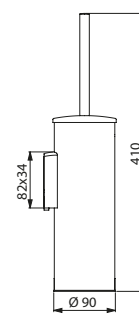
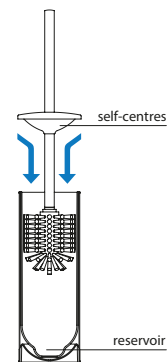

4051

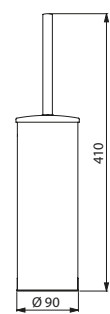

4050

Wall-mounted toilet brush set with lid - Anti-theft lock	
Bright polished 304 stainless steel	4051P
Polished satin 304 stainless steel	4051S
White powder-coated 304 stainless steel	4051EW
Floor-standing toilet brush set with lid	
Bright polished 304 stainless steel	4050P
Polished satin 304 stainless steel	4050S
White powder-coated 304 stainless steel	4050EW

Toilet brush set with lid

With anti-theft lock and **long handle**



Bright polished 304 stainless steel



Polished satin 304 stainless steel



White powder-coated 304 stainless steel

- **Robust model.**
- **Bacteriostatic 304 stainless steel.**
- Wall-mounted or floor-standing.
- **Long, ergonomic handle:** easy for wheelchair users or people who have difficulty bending to use.
- Easy to clean: plastic bowl can be removed from above.
- **Plastic bowl with reservoir:** prevents toilet brush sitting in residual water and reduces the risk of splashing when next used.
- Toilet brush **automatically centres itself** in the holder.
- **Anti-theft lock** (wall-mounted model).
- Stainless steel thickness: 1mm body.
- Dimensions: Ø 90 × 580mm.

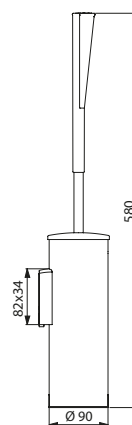
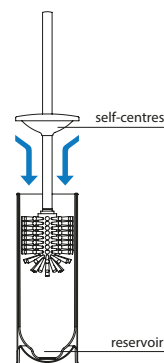

510051

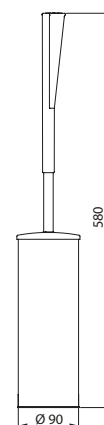

510050

Wall-mounted toilet brush set with lid and long handle - Anti-theft lock	
Bright polished 304 stainless steel	510051P
Polished satin 304 stainless steel	510051S
White powder-coated 304 stainless steel	510051W
Floor-standing toilet brush set with lid and long handle	
Bright polished 304 stainless steel	510050P
Polished satin 304 stainless steel	510050S
White powder-coated 304 stainless steel	510050W

Toilet brush set

With anti-theft lock and long handle



- High-strength polyamide (Nylon).
- Long, ergonomic handle: easy for wheelchair users or people who have difficulty bending to use.
- Easy to clean: plastic bowl can be removed from above.
- Plastic bowl with reservoir: prevents toilet brush sitting in residual water and reduces the risk of splashing when next used.
- Wall-mounted with anti-theft lock.
- Height 515mm.

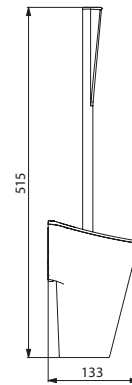

4051N

Toilet brush set, HR Nylon bright white with long handle
Anti-theft **4051N**

Toilet brush set

With removable bowl



- Wall-mounted or floor-standing.
- Removable bowl.
- Dimensions: 125 × 125 × 350mm.

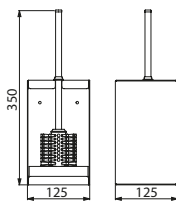

448

Toilet brush set with removable bowl
Bright polished 304 stainless steel **448**
Replacement brush, bright polished stainless steel **448BIS**

Toilet seat protector dispenser



- Vandal-resistant model.
- Hinged cover with lock and standard DELABIE key.
- Wall-mounted.
- Stainless steel thickness: 1mm.
- Dimensions: 43 × 410 × 270mm.

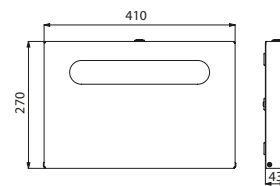

3561

Toilet seat protector dispenser
Bright polished stainless steel **3561**
Box of 250 toilet seat protectors **3562**

Hygienic bag dispenser and bin



- Bin with flap on top.
- Hygienic bag dispenser beneath.
- Capacity: 9 litres.
- Hinged cover with lock and **standard DELABIE key**.
- Wall-mounted.
- Stainless steel thickness: 1mm.
- Dimensions: 123 × 250 × 350mm.

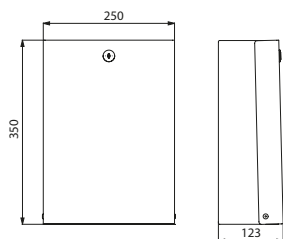

2561D

Hygienic bag dispenser and bin Bright polished stainless steel	2561D
---	-------

Wall-mounted paper dispenser

For rolls



- Vandal-resistant model.
- Central divider accessed from below.
- With lock and **standard DELABIE key**.
- Level control.
- Wall-mounted.
- Stainless steel thickness: 1mm.
- Dimensions: 215 × 215 × 265mm.

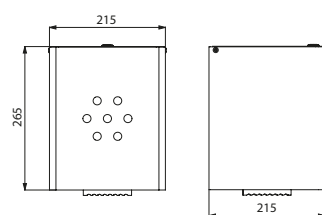

6590

Wall-mounted paper towel disp. for rolls Bright polished st. steel	6590
---	------

Wall-mounted paper dispenser

For 500 paper towels



- Robust model.
- Bacteriostatic 304 stainless steel.
- With lock and **standard DELABIE key**.
- Level control.
- Capacity: 500 sheets.
- Stainless steel thickness: 1mm.
- Dimensions: 160 × 285 × 390mm.
- Paper towel dimensions: open 230 × 250mm, folded 115 × 250mm.

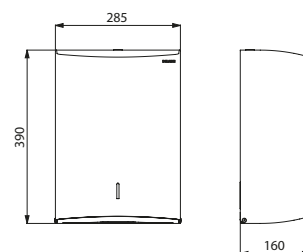

510602S

Wall-mounted paper towel dispenser Robust model - 500 sheets	
Polished satin 304 stainless steel	510602S
Folded paper towels, pack of 160 sheets	6606

Wall-mounted paper towel dispenser

For **500** paper towels



Bright polished 304 stainless steel



Polished satin 304 stainless steel



White powder-coated 304 stainless steel

- **Bacteriostatic 304 stainless steel.**
- With lock and **standard DELABIE key.**
- Level control.
- **Dispenses one sheet at a time.**
- **Capacity: 500 sheets.**
- Dimensions: 120 × 275 × 360mm.
- Paper towel dimensions: open 230 × 250mm, folded 115 × 250mm.

Wall-mounted paper towel dispenser - 500 sheets	
Bright polished 304 stainless steel	510601P
Polished satin 304 stainless steel	510601S
White powder-coated 304 stainless steel	510601W
Folded paper towels, pack of 160 sheets	6606

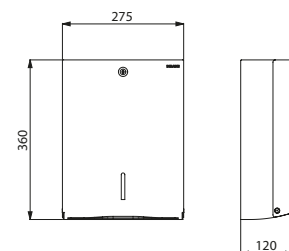

510601

Wall-mounted paper towel dispenser - Large model

For **750** paper towels



- With lock and **standard DELABIE key**.
- Level control.
- **Capacity: 750 sheets.**
- Metal thickness: 1mm.
- Dimensions: 130 × 275 × 450mm.
- Paper towel dimensions: open 230 × 250mm, folded 115 × 250mm.

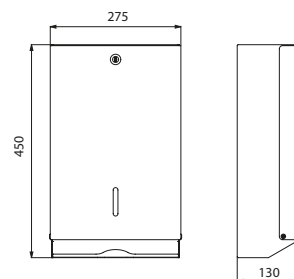

6601/6607D/6602

Wall-mounted paper towel dispenser - Large model - 750 sheets	
Bright polished stainless steel	6601
Polished satin stainless steel	6607D
White powder-coated	6602
Folded paper towels, pack of 160 sheets	6606

Wall-mounted bin for paper towels and waste paper

With flap, **16 litres**



- **System for fixing a bag in the bin.**
- With lock and **standard DELABIE key**.
- Bright polished stainless steel flap.
- Capacity: 16 litres.
- Metal thickness: 1mm.
- Dimensions: 130 × 275 × 475mm.

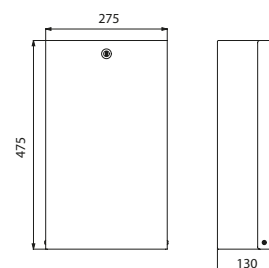

6611/6617/6612

16-litre wall-mounted bin for paper towels and waste paper	
Bright polished stainless steel	6611
Polished satin stainless steel	6617
White powder-coated	6612

Wall-mounted rectangular bin

Without lid, 38 litres



- Robust model.
- Bacteriostatic 304 stainless steel.
- Capacity: 38 litres.
- Stainless steel thickness: 1mm.
- Dimensions: 160 × 400 × 590mm.

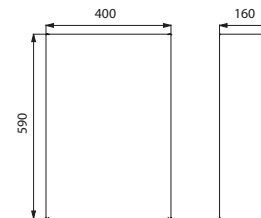

510463

38-litre bin without lid	
Bright polished 304 stainless steel	510463P
Polished satin 304 stainless steel	510463S

Wall-mounted rectangular bin

Without lid, 25 litres



- Robust model.
- Bacteriostatic 304 stainless steel.
- Capacity: 25 litres.
- Stainless steel thickness: 1mm.
- Dimensions: 155 × 355 × 460mm.

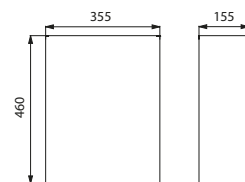

510461

25-litre bin without lid	
Bright polished 304 stainless steel	510461P
Polished satin 304 stainless steel	510461S

Wall-mounted rectangular bin
13 litres



- **Robust model.**
- Bright polished stainless steel.
- Capacity: 13 litres.
- Stainless steel thickness: 1mm.
- Dimensions: 150 × 280 × 320mm.

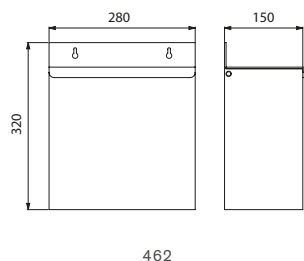

13-litre bin - Bright polished stainless steel	
Without lid	460
With lid	462

Slimline wall-mounted bin
With lid, 4.5 litres



- **Robust model with lid.**
- Stainless steel.
- Capacity: 4.5 litres.
- Stainless steel thickness: 1mm.
- Dimensions: 70 × 210 × 310mm.

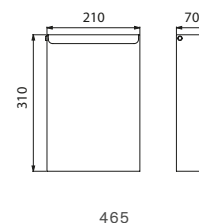

4.5-litre bin with lid	
Bright polished stainless steel	465
Polished satin stainless steel	465S

Round pedal bin
5 and 3 litres



- Stainless steel.
- With plastic liner.
- Capacity: 5 or 3 litres.
- **For use with 5-litre bags.**
- 5L model dimensions: Ø 203mm, height 285mm.
- 3L model dimensions: Ø 170mm, height 265mm.

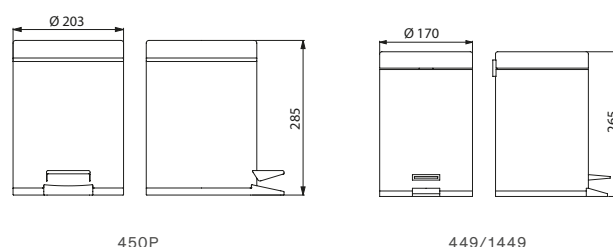

5-litre pedal bin	
Bright polished stainless steel	450P
3-litre pedal bin	
Bright polished stainless steel	449
White powder-coated stainless steel	1449

Liquid soap dispenser



- Polished satin bacteriostatic 304 stainless steel.
- Door with lock and **standard DELABIE key**.
- Plastic tank.
- **Concealed fixings**.
- Capacity: 1 litre.
- Stainless steel thickness: 1.2mm.
- Dimensions: 107 × 245 × 150mm.
- For chlorine-free and pH neutral soap.

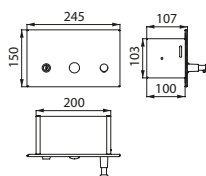

510711S

Paper towel dispenser



- Polished satin bacteriostatic 304 stainless steel.
- Door with lock and **standard DELABIE key**.
- **Concealed fixings**.
- Capacity: 400 - 600 towels.
- Stainless steel thickness: 1.2mm.
- Dimensions: 122 × 330 × 435mm.

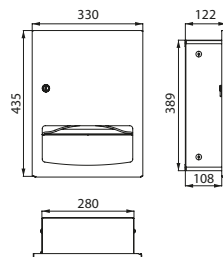

510712S

Waste bin with flap



- Polished satin bacteriostatic 304 stainless steel.
- **PUSH flap**.
- Door with lock and **standard DELABIE key**.
- **Concealed fixings**.
- Capacity: 18 litres.
- Stainless steel thickness: 1.2mm.
- Dimensions: 100 × 360 × 710mm.

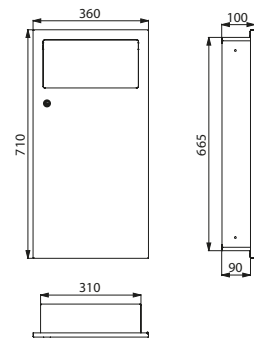

510713S

Soap dispenser	510711S
----------------	---------

Paper towel dispenser	510712S
-----------------------	---------

Waste bin with flap	510713S
---------------------	---------



MINERALCAST wash trough **454182** - Pedestal for MINERALCAST wash trough **454010** - TEMPOMATIC 4 electronic tap **440006**
Wall-mounted electronic liquid soap dispenser **510587** - Recessed combi paper towel dispenser / bin **510715S**

Combi paper towel dispenser/bin 10 litres



- Polished satin bacteriostatic 304 stainless steel.
- Door with lock and **standard DELABIE key**.
- **Concealed fixings**.
- Dispenser capacity: 400 - 600 towels.
- Waste bin capacity: 10 litres.
- Stainless steel thickness: 1.2mm.
- Dimensions: 125 × 330 × 790mm.

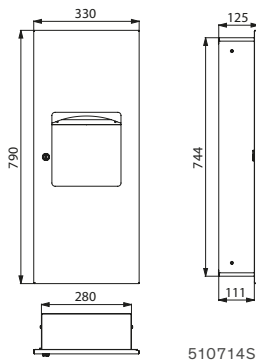

Combi dispenser/bin 10 litres **510714S**

Combi paper towel dispenser/bin 30 litres



- Polished satin bacteriostatic 304 stainless steel.
- Door with lock and **standard DELABIE key**.
- **Concealed fixings**.
- Dispenser capacity: 400 - 600 towels.
- Waste bin capacity: 30 litres.
- Stainless steel thickness: 1.2mm.
- Dimensions: 160 × 395 × 1,395mm.

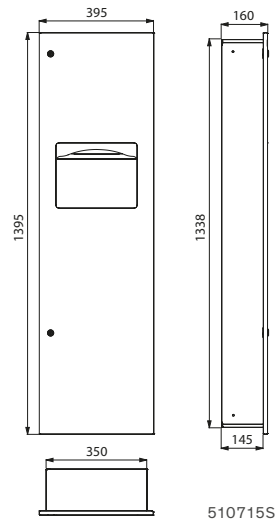

Combi dispenser/bin 30 litres **510715S**

Combi hand dryer and paper towel dispenser/bin



- Polished satin bacteriostatic 304 stainless steel.
- Door with lock and **standard DELABIE key**.
- **Concealed fixings**.
- Dispenser capacity: 400 - 600 towels.
- Hand dryer power: 1,800W.
- IP23. 3-year warranty. CE marked.
- Waste bin capacity: 15 litres.
- Stainless steel thickness: 1.2mm.
- Dimensions: 160 × 395 × 1,420mm.

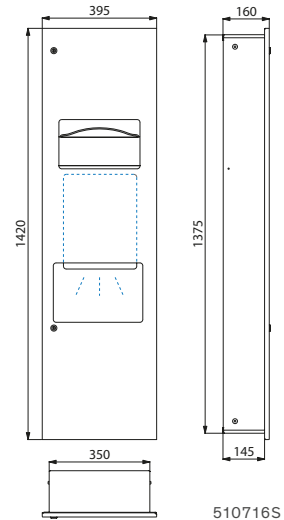

Combi dispenser/bin hand dryer **510716S**



Countertop ALGUI washbasin **120110** - BINOPTIC electronic tap **379ENC** - Rectangular stainless steel mirror **3459**
Wall-mounted electronic liquid soap dispenser **512066S** - HIGHFLOW high-speed air pulse hand dryer **510622S**

HIGHFLOW air pulse hand dryer



- **Robust model.**
- **Lit central nozzle concentrates pulsed air onto hands at 230km/h.**
- **High speed:** dries in 10 to 12 seconds.
- Choice of **warm or cold air** via concealed switch.
- Infrared automatic activation.
- Intelligent technology: stops automatically when hands are removed.
- Anti-blocking: stops automatically if used continuously for more than 60 seconds.
- **Bacteriostatic 304 stainless steel.**
- Easy to clean: one-piece cover.
- Stainless steel thickness: 1mm.
- Dimensions: 175 × 238 × 267mm.
- Weight: 4kg.
- Airflow: 39 l/second. Air speed: 230km/h.
- Low energy consumption: 1,350W.
- 220-240V~ / **50 Hz.**
- Noise level: 70 dBA.
- Class I, IP23.
- CE marked.
- **3-year warranty.**



High speed drying
10 to 12 sec.

*White model: provisional availability 1st half 2019.
Please contact the sales office to check availability.*

HIGHFLOW air pulse hand dryer	
Bright polished 304 stainless steel cover	510622
Polished satin 304 stainless steel cover	510622S
White powder-coated 304 stainless steel cover	510622W

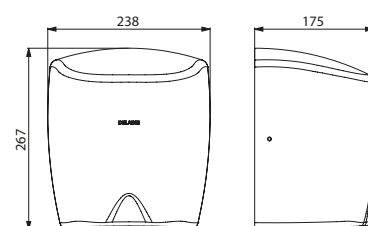

510622

SPEEDJET air pulse hand dryer



- Two-way air pulse hand dryer.
- **High speed:** dries in 10 to 18 seconds.
- **Removable drip tray** prevents any water dripping onto the wall or floor: easy to clean and service.
- ON/OFF button: easy to service.
- **Anti-bacterial air filter and activated carbon filter.**
- Infrared automatic activation.
- Intelligent technology: stops automatically when hands are removed or after 18 seconds.
- LCD screen with animated user guide and automatic stand-by.
- Dimensions: 250 × 292 × 650mm.
- Weight: 11.4kg.
- Brushless motor, no wear.
- **Energy saving: power 850W.** No heating element.
- 220-240V~ / **50-60Hz.**
- Airflow: 42 l/second. Air speed: 310km/h.
- Noise level: 75-80 dBA.
- Class I, IP22.
- CE marked.
- **3-year warranty.**

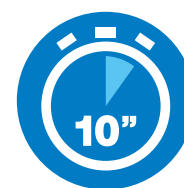

**High speed drying
10 to 18 sec.**

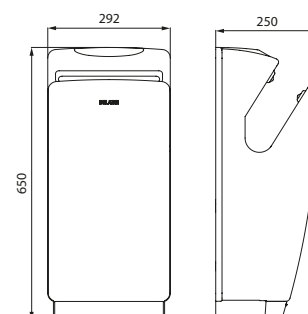
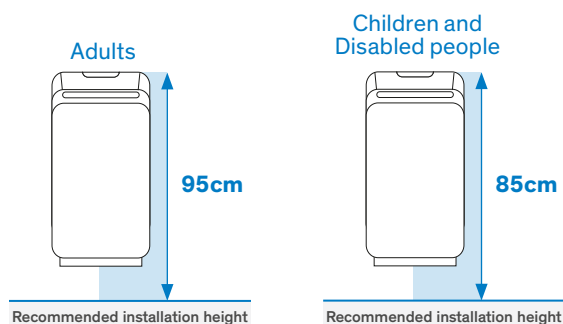

SPEEDJET air pulse hand dryer, metallic grey	510621
--	--------

510621

SPEEDJET 2 air pulse hand dryer

Antibacterial ABS



- Two-way air pulse hand dryer.
- **High speed:** dries in 10 to 12 seconds.
- Comfort: warm air.
- **Antibacterial ABS** for maximum hygiene.
- Easy to clean and service: **residual water on hands is eliminated with new automatic procedure** using evaporation and sterilisation. Features system that removes the need for a drip tray and prevents water reaching the wall or floor.
- **HEPA filter:** prevents 99.99% of airborne bacteria.
- Infrared automatic activation.
- Intelligent technology: stops automatically when hands are removed.
- Anti-blocking: stops automatically if used continuously for more than 30 seconds.
- Dimensions: 180 × 320 × 540mm.
- Weight: 7.2kg.
- **Energy saving:** heating element stops automatically once temperature reaches > 25°C.
- Low energy consumption: 1,050W in non-heating mode, 1,550W in heating mode.
- 220-240V~ / **50-60 Hz.**
- Airflow: 61 l/second. Air speed: 540km/h.
- Noise level: 66 dBA.
- Class II, IP21.
- CE marked.
- **3-year warranty.**



High speed drying
10 to 12 sec.

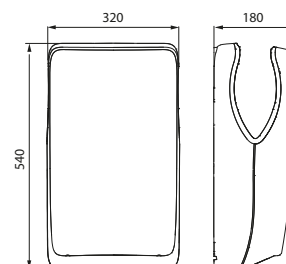

510623

Provisional availability 1st half 2019. Please contact the sales office to check availability.

SPEEDJET 2 air pulse hand dryer	
Metallised anthracite	510623C
Matte white	510623W

Automatic hand dryer

With 360° rotating nozzle



- **Vandal-resistant model.**
- Automatically activated by optical cell.
- **360° rotating nozzle.**
- Metal thickness: 1.2mm.
- Dimensions: 210 × 280 × 220mm.
- Weight: 3.5kg.
- **Power: 2,000W. 50-60Hz.**
- Airflow: 95 l/second.
- **Low noise level: 68 dBA.**
- Maximum safety, Class II insulation (double electrical insulation), IP23.
- CE marked, TÜV GS.
- **3-year warranty.**

Automatic hand dryer with 360° rotating nozzle	
Bright polished 304 stainless steel cover	6613D
Polished satin 304 stainless steel cover	6614
White enamelled cast steel cover	6615

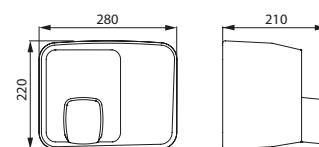

6613D/6614/6615

Automatic hand dryer



CE

- Automatically activated by optical cell.
- Dimensions: 160 × 225 × 300mm.
- Weight: 3.8kg.
- **Power: 1,960W. 50Hz.**
- Airflow: 65 l/second.
- **Low noise level: 58 dBA.**
- Class II (ref. 6621), Class I (ref. 6631), IPX1.
- CE marked, TÜV GS.
- **3-year warranty.**

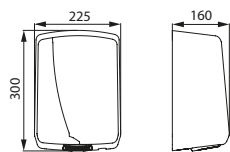

6631/6621

Automatic hand dryer	
Bright polished 304 stainless steel cover	6631
White ABS cover	6621

Hair dryer with socket for shavers



CE

- Operated by sensor switch.
- Safety switch on the cradle.
- 2 drying temperatures.
- **Shaver socket.**
- White ABS cover.
- Dimensions: 90 × 180 × 170mm.
- Weight: 1.3kg.
- **Power: 1,200W.**
- Airflow: 14 l/second.
- Class II. CE marked.
- **3-year warranty.**

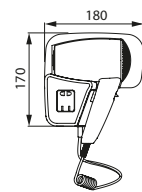

6624

Hair dryer	6624
-------------------	-------------



Electronic, liquid or foam soap dispenser

Wall-mounted or cross wall, mains supply



- Wall-mounted or **vandal-resistant cross wall (TC)** up to 110mm.
- **No manual contact:** infrared cell detects hands automatically.
- Chrome-plated 304 stainless steel spout.
- **No waste pump dispenser:** 0.8ml dose (can be adjusted up to 7 doses per detection).
- Independent electronic housing and removable tank enable installation beneath the washbasin.
- 230/12V mains supply with transformer.
- For vegetable-based **liquid soap** with a maximum viscosity of 3,000 mPa.s or **specific foam soap**.
- Spout length: 115mm.
- CE marked.

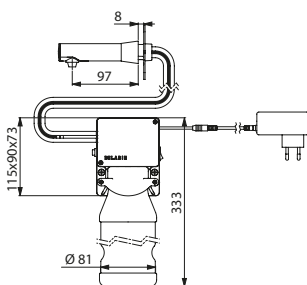

512051

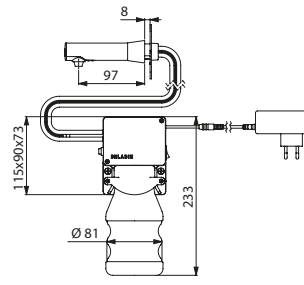

512551

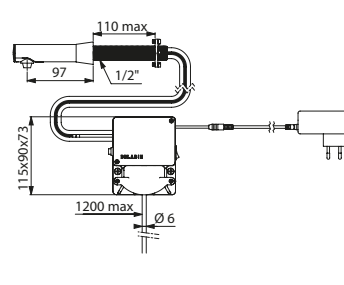

512111

Provisional availability 2nd half 2019. Please contact the sales office to check availability.

Electronic, liquid or foam soap dispenser, mains supply - chrome-plated 304 stainless steel

Wall-mounted, with tank 1 litre	512051P
Wall-mounted, with tank 0.5 litre	512551P
Wall-mounted, with flexible tube 1.20m for remote tank	512151P
Cross wall, with flexible tube 1.20m for remote tank	512111P



DELABIE

Electronic liquid soap dispenser

Wall-mounted, battery-operated



- **Vandal-resistant model with lock and standard DELABIE key.**
 - **No manual contact:** hands are automatically detected by infrared cell (detection distance can be adjusted).
 - **Bacteriostatic 304 stainless steel** cover.
 - **One-piece hinged cover** for easy maintenance and better hygiene.
 - **No waste pump dispenser:** dispenses 0.8ml (can be adjusted up to 7 doses per activation).
 - Option of operation in **anti-clogging mode.**
 - Power supply: 6 AA -1.5V (DC9V) batteries
- supplied integrated in the soap dispenser body.
 - Low battery indicator light.
 - Tank with large opening: eases transfer of soap from large containers.
 - Window allows soap level to be checked.
 - Stainless steel thickness: 1mm.
 - Capacity: 1 litre.
 - For vegetable-based liquid soap with a maximum viscosity of 3,000 mPa.s.
 - Compatible with hydroalcoholic gel.
 - CE marked.

Provisional availability 1st half 2019. Please contact the sales office to check availability.

Electronic liquid soap dispenser - Wall-mounted, battery-operated	
Bright polished 304 stainless steel, 1 litre	512066P
Polished satin 304 stainless steel, 1 litre	512066S
White powder-coated 304 stainless steel, 1 litre	512066W

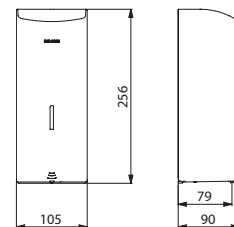

512066

Round electronic liquid soap dispenser

Wall-mounted, battery-operated



- **No manual contact:** hands are automatically detected by infrared cell (detection distance can be adjusted).
- Bright polished **bacteriostatic 304 stainless steel** body and fixing plate.
- **No waste pump dispenser:** dispenses 0.8ml (can be adjusted up to 7 doses per activation).
- Power supply: 6AA -1.5V (DC9V) batteries supplied integrated in the soap dispenser body.
- With lock.
- Low battery indicator light.
- Window allows soap level to be checked.
- Capacity: 0.65 litre.
- For vegetable-based liquid soap with a maximum viscosity of 3,000 mPa.s.
- CE marked.

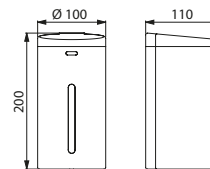

510587

Round electronic liquid soap dispenser Wall-mounted, battery-operated - 1 litre	510587
--	---------------

Liquid soap dispenser with soft-touch operation

Wall-mounted, **0.5 or 1 litre**



Bright polished 304 stainless steel, 1-litre model



Polished satin 304 stainless steel, 0.5-litre model



White powder-coated 304 stainless steel, 0.5-litre model

- **Vandal-resistant model with lock and standard DELABIE key.**
- **Bacteriostatic 304 stainless steel cover.**
- **One-piece hinged cover** for easy maintenance and better hygiene.
- **Push-button with soft-touch operation.**
- **Anti-blocking:** single dose per press even when the button is pressed for long periods.
- No waste, non-drip (waterproof) pump-action dispenser.
- Tank with large opening: eases transfer of soap from large containers.
- Tank prevents long-term stagnation of soap.
- Window allows soap level to be checked.
- Stainless steel thickness: 1mm.
- Capacity: 0.5 or 1 litre.
- 0.5-litre model dimensions: 90 × 105 × 185mm.
- 1-litre model dimensions: 90 × 105 × 252mm.
- For vegetable-based liquid soap with a maximum viscosity of 3,000 mPa.s.
- Compatible with hydroalcoholic gel.

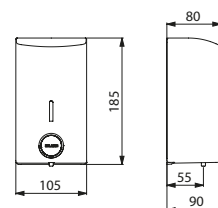

510583/510586/510584

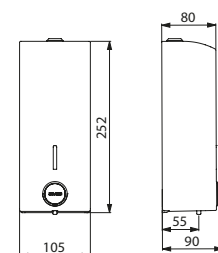

510580/510582/510581

Liquid soap dispenser with soft-touch operation - 0.5 litre	
Bright polished 304 stainless steel	510583
Polished satin 304 stainless steel	510586
White powder-coated 304 stainless steel	510584
Liquid soap dispenser with soft-touch operation - 1 litre	
Bright polished 304 stainless steel	510580
Polished satin 304 stainless steel	510582
White powder-coated 304 stainless steel	510581

Cross wall liquid soap dispenser

Wall-mounted for cross wall installation



- **Vandal-resistant model for cross wall installation (TC)**, for walls up to 180mm.
- Chrome-plated brass body and push-button.
- Non-drip system (waterproof).
- **Mechanism can be locked via a grub screw.**
- **For remote tanks** (tank not supplied) with 1.20m flexible tube.

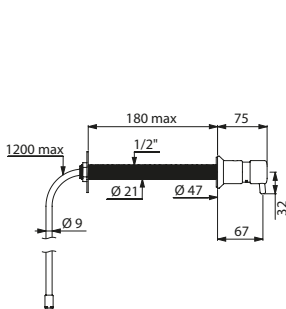

729150

Cross wall liquid soap dispenser for remote tanks	729150
--	---------------

Liquid soap dispenser

Deck-mounted, **straight spout**



- Model for installing on washbasins.
- **Vandal-resistant model.**
- Chrome-plated brass body and push-button.
- Non-drip system (waterproof).
- **Mechanism can be locked via a grub screw.**
- Top fill (by unscrewing the push-button) or from the lower part (by unscrewing the bottle).

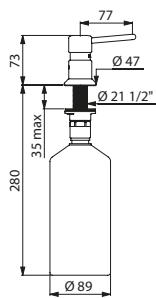

729008

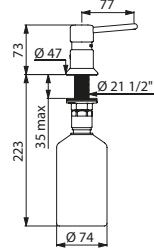

729508

Deck-mounted liquid soap dispenser Straight spout	
With 1-litre bottle	729008
With 0.5-litre bottle	729508
With flexible tube 1.20m for remote tank	729108

Liquid soap dispenser

Deck-mounted, **curved spout**



- Model for installing on washbasins.
- **Vandal-resistant model.**
- Chrome-plated brass body and push-button.
- Non-drip system (waterproof).
- **Mechanism can be locked via a grub screw.**
- Top fill (by unscrewing the push-button) or from the lower part (by unscrewing the bottle).

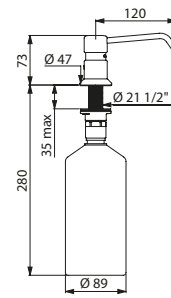

729012

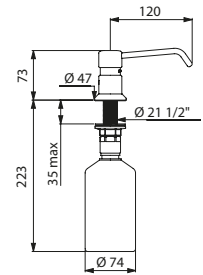

729512

Deck-mounted liquid soap dispenser Curved spout	
With 1-litre bottle	729012
With 0.5-litre bottle	729512
With flexible tube 1.20m for remote tank	729112

Rectangular liquid soap dispenser 1 litre

Wall-mounted



- **Vandal-resistant model with lock and standard DELABIE key.**
- No waste, non-drip (waterproof) pump-action dispenser.
- **Bacteriostatic 304 stainless steel.**
- Stainless steel thickness: 1mm.
- Capacity: 1 litre.
- Dimensions: 108 × 108 × 230mm.

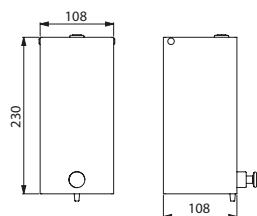

6580/6582

Rectangular liquid soap dispenser 1 litre	
Bright polished 304 stainless steel	6580
Polished satin 304 stainless steel	6582

Rectangular liquid soap dispenser 0.5 litre

Wall-mounted



- **Vandal-resistant model with lock and standard DELABIE key.**
- No waste, non-drip (waterproof) pump-action dispenser.
- **Bacteriostatic 304 stainless steel.**
- Stainless steel thickness: 1mm.
- Capacity: 0.5 litre.
- Dimensions: 108 × 108 × 142mm.

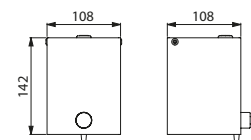

6583/6586

Rectangular liquid soap dispenser 0.5 litre	
Bright polished 304 stainless steel	6583
Polished satin 304 stainless steel	6586

Soap dish

304 stainless steel, wall-mounted



- **Robust model.**
- For showers or washbasins.
- **Bacteriostatic 304 stainless steel.**
- Stainless steel thickness: 1.5mm.
- **Concealed fixings.**



Stainless steel soap dish	
Bright polished 304 stainless steel	510627P
Polished satin 304 stainless steel	510627S

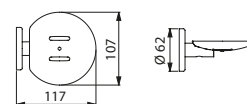

510627

Wire soap basket

Stainless steel, wall-mounted

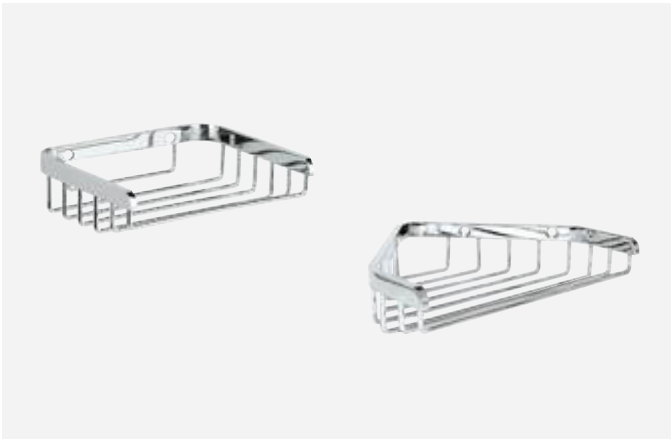

- **Robust model.**
- Bright polished stainless steel.
- Rectangular model dimensions: 100 × 130 × 34mm.
- Corner model dimensions: 120 × 165 × 34mm.

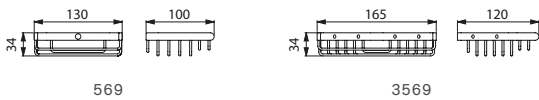

Bright polished stainless steel wire soap basket	
Rectangular	569
Corner	3569

Soap dish

Wall-mounted



- **Robust model.**
- **Concealed fixings.**
- Dimensions: 60 × 160 × 40mm.

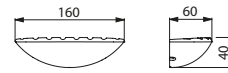

710501/710500

Soap dish	
Bright chrome-plated Bayblend®	710501
Matte chrome-plated Bayblend®	710500

Hook

Chrome-plated brass



- Chrome-plated brass.
- Dimensions: 32 × 15 × 34mm.

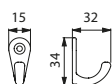

138

Chrome-plated brass clothes hook	138
----------------------------------	------------

Hook

304 stainless steel



- **Bright polished 304 stainless steel.**
- **Thickness: 2mm.**
- Dimensions: 50 × 25 × 145mm.

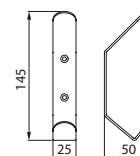

101P

304 stainless steel clothes hook	101P
----------------------------------	-------------

Coat hook

304 stainless steel, **short** model

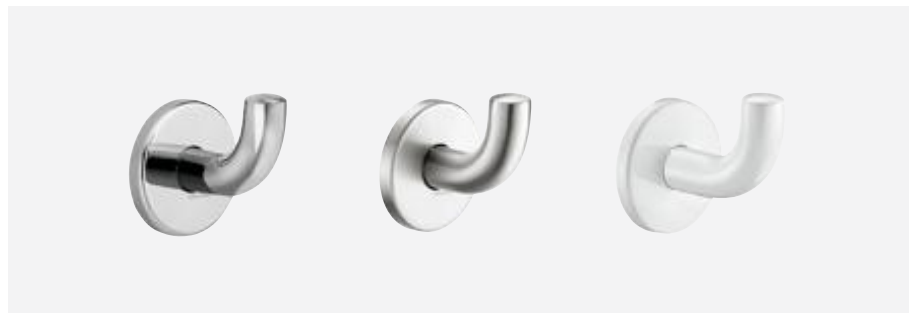

- **Bacteriostatic 304 stainless steel.**
- Tube Ø 20mm, 1mm thick.
- **Concealed fixings.**
- Dimensions: Ø 62 × 65 × 73mm.

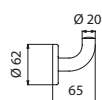

4043

Coat hook - Short model	
Bright polished 304 stainless steel	4043P
Polished satin 304 stainless steel	4043S
White powder-coated 304 stainless steel	4043EW

Double coat hook

304 stainless steel



- **Bacteriostatic 304 stainless steel.**
- Tube Ø 20mm, 1mm thick.
- **Concealed fixings.**
- Dimensions: Ø 62 × 55 × 95mm.

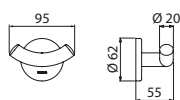

4042

Double coat hook	
Bright polished 304 stainless steel	4042P
Polished satin 304 stainless steel	4042S
White powder-coated 304 stainless steel	4042W

Coat hook

304 stainless steel, **long** model



- **Bacteriostatic 304 stainless steel.**
- Tube Ø 20mm, 1mm thick.
- **Concealed fixings.**
- Dimensions: Ø 62 × 100 × 73mm.

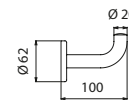

4047

Coat hook - Long model	
Bright polished 304 stainless steel	4047P
White powder-coated 304 stainless steel	4047EW

Coat hook

Nylon, **short** model



- **High-strength polyamide (Nylon).**
- Tube Ø 20mm.
- **Concealed fixings.**
- Dimensions: Ø 62 × 65 × 73mm.

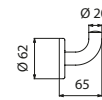

4043N

Coat hook HR Nylon bright white Short model	4043N
---	--------------

Robe hook

304 stainless steel, **1 hook**



- **Concealed fixings.**
- Dimensions: $\varnothing 65 \times 58$ mm.

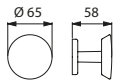

301/1301W

Robe hook, 1 hook

Bright polished and chrome-plated 304 st. steel	301
304 stainless steel and white powder-coated metal	1301W

Robe hooks

304 stainless steel, **2 hooks**



- **Concealed fixings.**
- Dimensions : $\varnothing 65 \times 215 \times 58$ mm.

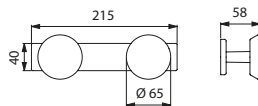

302/1302W

Robe hook, 2 hooks

Bright polished and chrome-plated 304 st. steel	302
304 stainless steel and white powder-coated metal	1302W

Robe hooks

304 stainless steel, **3 hooks**



- **Concealed fixings.**
- Dimensions : $\varnothing 65 \times 345 \times 58$ mm.

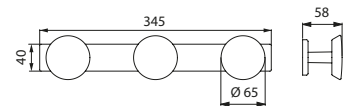

303D/1303W

Robe hook, 3 hooks

Bright polished and chrome-plated 304 st. steel	303D
304 stainless steel and white powder-coated metal	1303W

Ligature-resistant hook

304 stainless steel



- **Ligature-resistant:** the hook lowers with loads over 30kg.
- **Polished satin 304 stainless steel.**
- Dimensions: $\varnothing 90 \times 68$ mm.

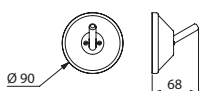

510104S

Ligature-resistant clothes hook 304 stainless steel	510104S
--	----------------

Double coat hook

Nylon



- **High-strength polyamide (Nylon).**
- Tube $\varnothing 10$ mm.
- **Concealed fixings.**

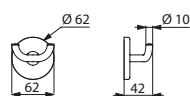

510042N

Double coat hook HR Nylon bright white	510042N
---	----------------

Single coat hook

Nylon

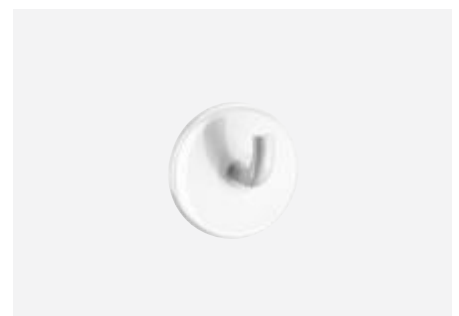

- **High-strength polyamide (Nylon).**
- Tube $\varnothing 10$ mm.
- **Concealed fixings.**

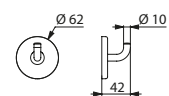

510043N

Single coat hook HR Nylon bright white	510043N
---	----------------

Stainless steel toilet sign

Self-adhesive

NEW



- Polished satin 304 stainless steel.
- Stainless steel thickness: 1.2mm.
- Dimensions: 125 × 125mm.

*"Changing facilities for babies": provisional availability 1st half 2019.
Please contact the sales office to check availability*

304 stainless steel toilet sign

Female sign	510151S
Male sign	510152S
WC sign	510154S
"Changing facilities for babies" sign	510156S

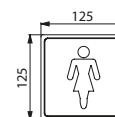

510151S

Stainless steel "Disabled signs"

Self-adhesive



- Polished satin 304 stainless steel.
- Stainless steel thickness: 1.2mm.
- Dimensions: 125 or 230 × 125mm.

304 stainless steel toilet sign

Disabled sign	510153S
Mixed disabled sign	510155S

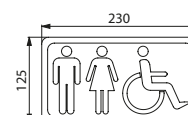

510155S

Towel rail Ø 20mmConcealed fixings, **1 rail**

- **Robust model.**
- **Bacteriostatic 304 stainless steel.**
- Tube Ø 20mm.
- **Concealed fixings.**
- Length 600mm.

Towel rail Ø 20mm concealed fixings - 1 rail	
Bright polished 304 stainless steel	510788P
Polished satin 304 stainless steel	510788S
White powder-coated 304 stainless steel	510788W

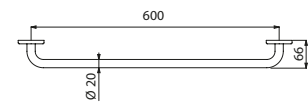

510788

Towel rail Ø 20mmConcealed fixings, **2 rails**

- **Robust model.**
- **Bacteriostatic 304 stainless steel.**
- Tubes Ø 20mm and Ø 16mm.
- **Concealed fixings.**
- Length 600mm.

Towel rail Ø 20mm concealed fixings - 2 rails	
Bright polished 304 stainless steel	510790P
Polished satin 304 stainless steel	510790S
White powder-coated 304 stainless steel	510790W

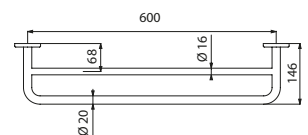

510790

Towel rail Ø 14mm

1 rail



- **Robust model.**
- Bright polished bacteriostatic 304 stainless steel.
- Tube Ø 14mm, metal thickness 1mm.
- Length 480mm.

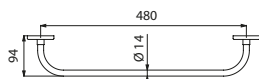

6784

Single towel rail Ø 14mm Bright polished 304 stainless steel	6784
---	-------------

Towel rail Ø 14mm

2 rails



- **Robust model.**
- Bright polished bacteriostatic 304 stainless steel.
- Tube Ø 14mm, metal thickness 1mm.
- Length 480mm.

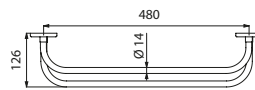

6786D

Double towel rail Ø 14mm Bright polished 304 stainless steel	6786D
---	--------------

Wall-mounted shelf



- 1mm thick.

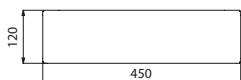

551/552

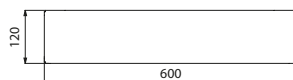

553/554

Bright polished 304 stainless steel shelf	
120 × 450mm	551
120 × 600mm	553
White powder-coated shelf	
120 × 450mm	552
120 × 600mm	554

Glass shelf with supports



- Glass shelf with rounded edges, **6mm thick**, 120 × 600mm.
- 120mm chrome-plated shelf supports.

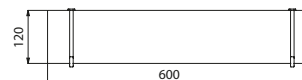

6555 + 600

Basin shelf with supports	
Glass shelf	6555
Chrome-plated supports	600

Tilting glass mirror
With long, ergonomic lever



- **For combined installation:** can be used from sitting or standing position.
- **Long, ergonomic lever for easy adjustment of mirror angle from a sitting position or from a wheelchair.**
- **Quick and easy to install:** just clip into place.
- **Anti-theft lock.**
- Bright white HR Nylon lever.
- Mirror made from 6mm Securit safety glass.
- Mirror dimensions: 500 × 600mm.
- Can be tilted up to 20°.

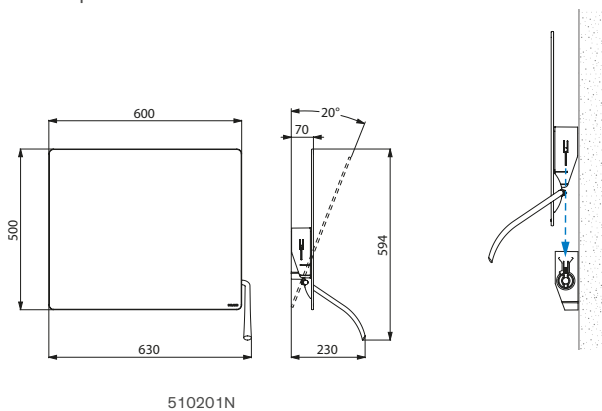

Tilting glass mirror
With tab handle



- **For combined installation:** can be used from sitting or standing position.
- **Tab handle for easy adjustment of mirror angle for those in a sitting position or for wheelchair users.**
- **Quick and easy to install:** just clip into place.
- **Anti-theft lock.**
- Mirror made from 6mm Securit safety glass.
- Mirror dimensions: 500 × 600mm.
- Can be tilted up to 20°.

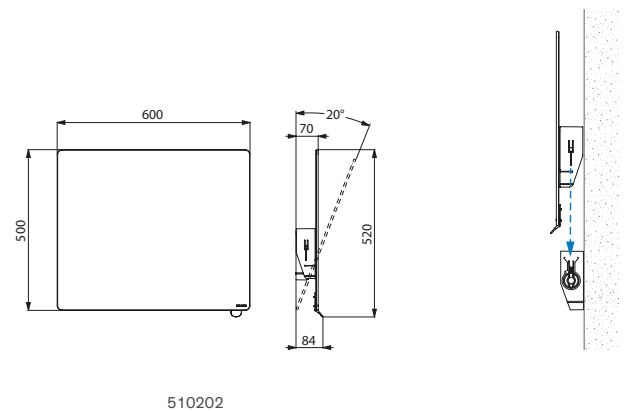

Glass mirror - With tab handle for tilting	
Chrome-plated bright tab handle	510202P
Chrome-plated satin tab handle	510202S
Metallised anthracite tab handle	510202C
White Nylon tab handle	510202N

Glass mirror - Tilting with long, ergonomic lever	510201N
---	----------------

Glass mirror



- 6mm thick.
- Individually packaged.
- Order mounting brackets separately.
- 3451 model dimensions: 6 × 360 × 480mm.
- 3450 model dimensions: 6 × 420 × 600mm.
- 3454 model dimensions: 6 × 500 × 750mm.

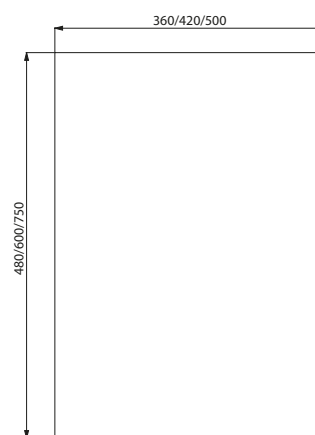

3451/3450/3454

Glass mirror	
360 × 480mm	3451
420 × 600mm	3450
500 × 750mm	3454

Round studded pegs



- Chrome-plated brass.
- Dimensions: Ø 20mm.
- Screw in.



578

Studded pegs with a spring

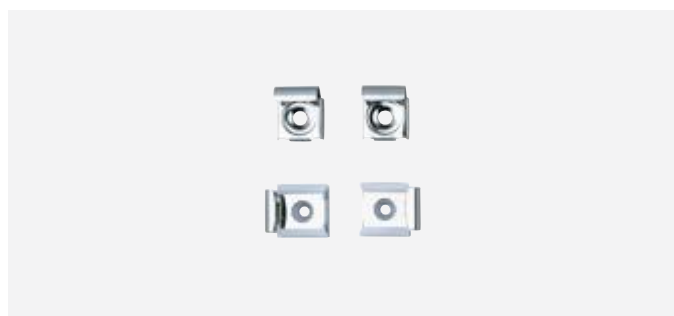

- Pack of 4 mounting pegs, 2 of which incorporate a spring.
- Bright polished stainless steel.

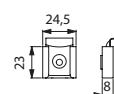

577

Round studded pegs	578
--------------------	-----

Pack of 4 studded pegs, 2 of which have springs	577
---	-----

Stainless steel mirror
Self-adhesive - H. 600mm



- **"Mirror" polished** bacteriostatic 304 stainless steel.
- Stainless steel thickness: 1mm.
- **Unbreakable.**
- Self-adhesive.
- Dimensions: 1 × 400 × 600mm.

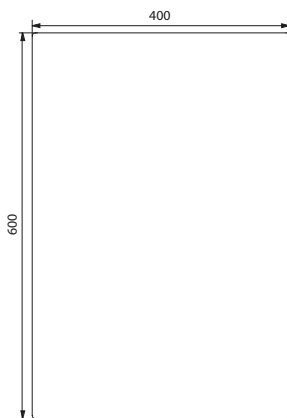

3453

Stainless steel mirror
Concealed fixings - H. 500/600/1,000mm

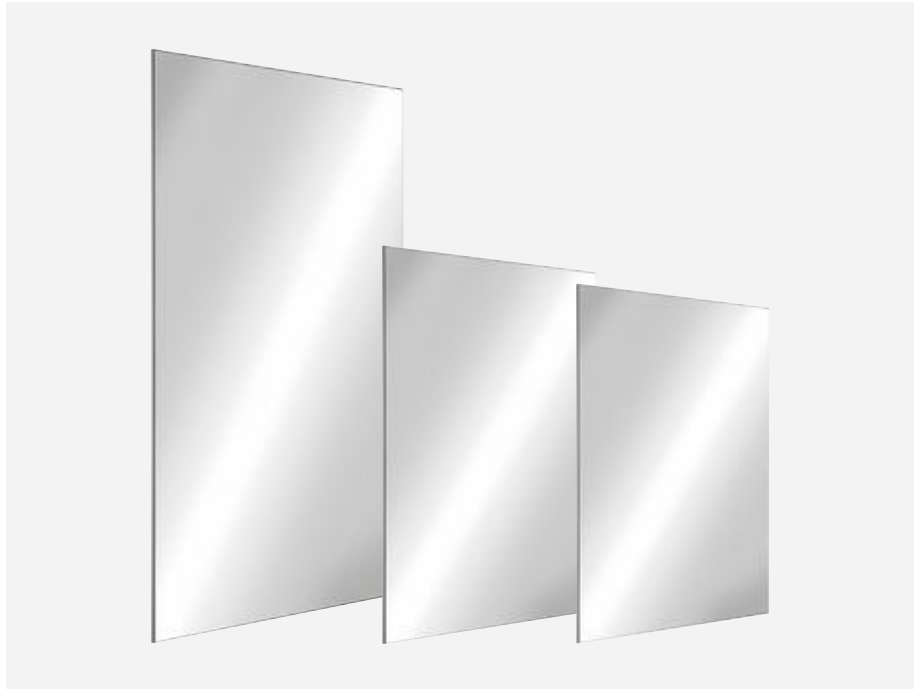

- **"Mirror" polished** bacteriostatic 304 stainless steel.
- **Reinforced by a concealed solid PVC plate** 10mm thick.
- 5 fixing points. Concealed fixings.
- **Unbreakable.**
- Model 3459: **for combined installation, height enables use from standing or sitting positions, or from a wheelchair.**
- 3452 model dimensions: 10 × 385 × 485mm.
- 3458 model dimensions: 10 × 485 × 585mm.
- 3459 model dimensions: 10 × 595 × 980mm.

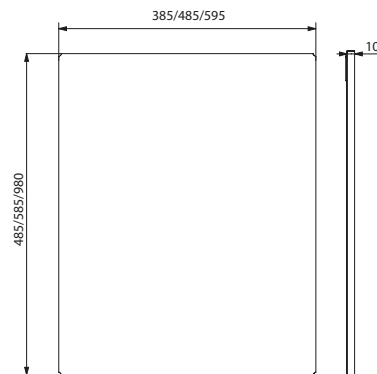

3452/3458/3459

Stainless steel mirror 1 × 400 × 600mm	3453
---	------

Stainless steel mirror - Concealed fixings	
10 × 385 × 485mm	3452
10 × 485 × 585mm	3458
10 × 595 × 980mm	3459

Satin finish Basic straight grab bar

Tube Ø 32mm



- Polished satin 304 stainless steel.
- Concealed fixings, secured to wall by a 3-hole stainless steel plate.
- CE marked.

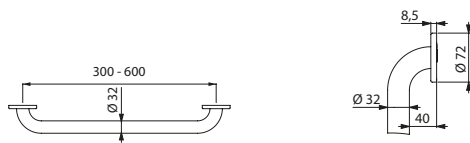

35050S/350504S/350505S/350506S

Basic straight grab bar Ø 32mm	
Polished satin 304 stainless steel - 300mm	35050S
Polished satin 304 stainless steel - 400mm	350504S
Polished satin 304 stainless steel - 500mm	350505S
Polished satin 304 stainless steel - 600mm	350506S

Satin finish Basic angled grab bar 135°

Tube Ø 32mm



- Polished satin 304 stainless steel.
- **3 fixing points prevent the hand from getting trapped and simplify installation.**
- Concealed fixings, secured to wall by a 3-hole stainless steel plate.
- Dimensions : 400 × 400mm.
- CE marked.

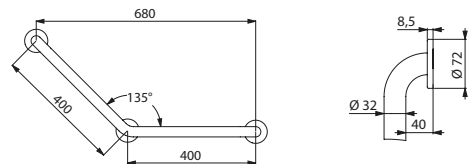

35082S

Basic angled grab bar 135° Ø 32mm Polished satin 304 stainless steel	35082S
--	---------------

White powder-coated Basic straight grab bar

Tube Ø 32mm



- White powder-coated stainless steel.
- Concealed fixings, secured to wall by a 3-hole stainless steel plate.
- CE marked.

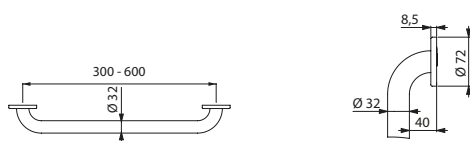

35050W/350504W/350505W/350506W

Basic straight grab bar Ø 32mm	
White powder-coated stainless steel - 300mm	35050W
White powder-coated stainless steel - 400mm	350504W
White powder-coated stainless steel - 500mm	350505W
White powder-coated stainless steel - 600mm	350506W

White powder-coated Basic angled grab bar 135°

Tube Ø 32mm



- White powder-coated stainless steel.
- **3 fixing points prevent the hand from getting trapped and simplify installation.**
- Concealed fixings, secured to wall by a 3-hole stainless steel plate.
- Dimensions: 400 × 400mm. CE marked.

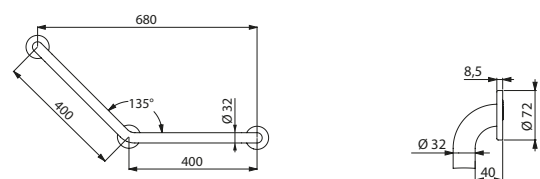

35082W

Basic angled grab bar 135° Ø 32mm White powder-coated stainless steel	35082W
---	---------------

Bright ECO straight grab bar

Tube Ø 25mm



- Bright polished 304 stainless steel.
- Visible fixings, secured to wall by a 3-hole plate.

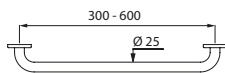

530/531/532/536

ECO straight grab bar Ø 25mm	
Bright polished 304 stainless steel - 300mm	530
Bright polished 304 stainless steel - 400mm	531
Bright polished 304 stainless steel - 500mm	532
Bright polished 304 stainless steel - 600mm	536

Bright ECO angled grab bar 135°

Tube Ø 25mm



- Bright polished 304 stainless steel.
- Visible fixings, secured to wall by a 3-hole plate.
- Dimensions: 220 × 220mm.

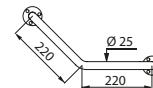

550

ECO angled grab bar 135° Ø 25mm Bright polished 304 stainless steel	550
--	-----

White powder-coated ECO straight grab bar

Tube Ø 25mm



- White powder-coated stainless steel.
- Visible fixings, secured to wall by a 3-hole plate.
- Dimensions: 300mm.

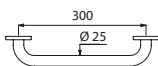

1530

ECO straight grab bar Ø 25mm White powder-coated stainless steel - 300mm	1530
---	------

White powder-coated ECO angled grab bar 135°

Tube Ø 25mm



- White powder-coated stainless steel.
- Visible fixings, secured to wall by a 3-hole plate.
- Dimensions: 220 × 220mm.

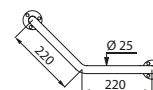

1550

ECO angled grab bar 135° Ø 25mm White powder-coated stainless steel	1550
--	------

DELABIE / Straight or angled shower curtain rail assembly kit

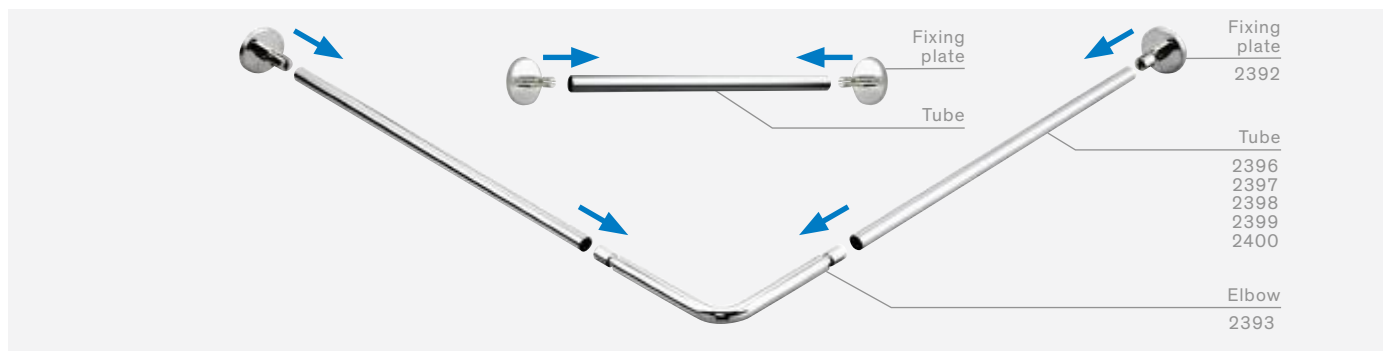

Fixing plate



- For \varnothing 20mm tube.
- **Concealed fixings via 304 stainless steel plate.**
- With push-fit connectors for mounting.
- Supplied with 4 screws 4×30 mm and 4 rawl plugs.

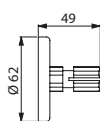

2392

Pack of 2 fixing plates

2392

Sleeve connector



- To connect 2 straight tubes.
- Connects $2 \times \varnothing$ 20mm tubes.
- Dimensions: \varnothing 18 \times 60mm.



2390

Sleeve connector

2390

Elbow connector



- To connect $2 \times \varnothing$ 20mm tubes.
- 304 stainless steel.
- With push-fit connectors for mounting.
- Dimensions: 150×150 mm.

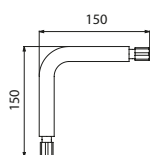

2393

Elbow connector

2393

Connecting tubes



- Cut-to-size.
- Bright polished 304 stainless steel, 1mm thick.
- Tube \varnothing 20mm.
- **Longer tubes available on request.**

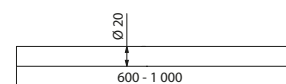

2396/2397/2398/2399/2400

Connecting tubes

600mm	2396
700mm	2397
800mm	2398
900mm	2399
1,000mm	2400

Straight curtain rail, cut-to-size



- **Cut-to-size.**
- Bright polished 304 stainless steel.
- Tube Ø 16mm, 1mm thick.

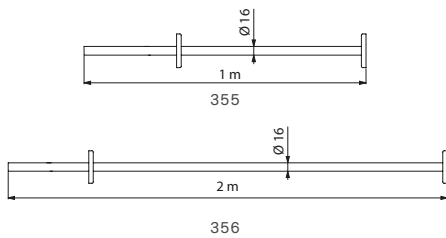

Straight curtain rail, cut-to-size	
Ø 16mm, 1m	355
Ø 16mm, 2m	356

See our ceiling supports for curtain rails on page 48.

Cut-to-size straight curtain rail Concealed fixings



- **Cut-to-size.**
- Bright polished 304 stainless steel.
- **Concealed fixings.**
- Tube Ø 20mm, 1mm thick.

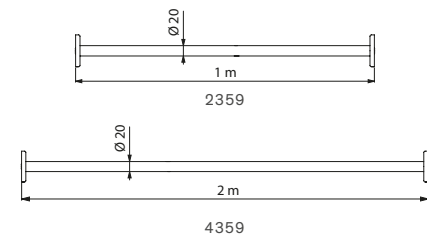

Straight curtain rail, cut-to-size - Concealed fixings	
Ø 20mm, 1m	2359
Ø 20mm, 2m	4359

See our ceiling supports for curtain rails on page 48.

Adjustable straight curtain rail



- **Adjusts from 0.80m - 1.40m simply by rotating the tube.**
- Bright polished 304 stainless steel.
- Tube Ø 20mm, 1mm thick.

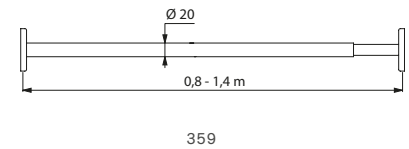

Adjustable straight curtain rail Ø 20mm	359
--	------------

See our ceiling supports for curtain rails on page 48.

Telescopic, straight curtain rail ECO



- **Telescopic.**
- Polished aluminium tube.

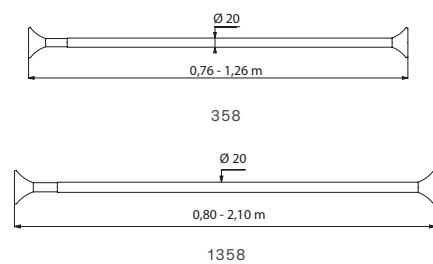

Telescopic, straight curtain rail	
Ø 20mm, from 0.76 to 1.26m	358
Ø 20mm, from 0.80 to 2.10m	1358

Fixed, angled curtain rail



- Bright polished 304 stainless steel.
- 1mm thick.
- Concealed fixings (Ref. 1367).

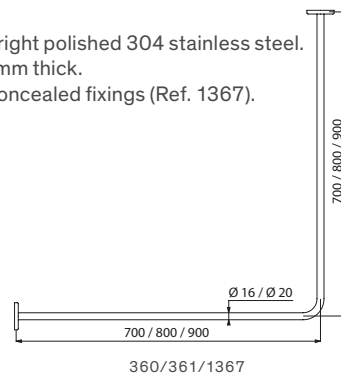

Fixed, angled curtain rail	
Ø 16mm, 700 × 700mm	360
Ø 16mm, 800 × 800mm	361
Ø 20mm, 900 × 900mm	1367

See our ceiling supports for curtain rails on page 48.

Adjustable, angled curtain rail



- **Adjusts from 700 – 900mm on either side.**
- Bright polished 304 stainless steel.
- Tubes Ø 20mm and 16mm, 1mm thick.

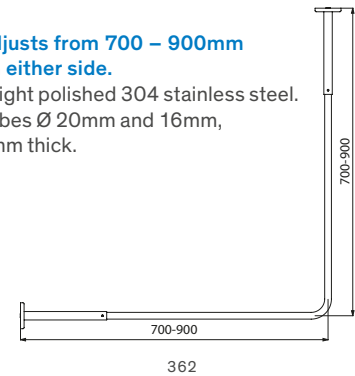

Adjustable, angled curtain rail	362
--	------------

See our ceiling supports for curtain rails on page 48.

Shower curtain rail

Lift-up



- Allows side access in the raised position.
 - Preserves the patient's privacy in the lowered position.
 - Allows a carer to assist with bathing a patient while protecting them from splashes.
 - Dimensions: 900 × 230 × 105mm, Ø 32mm.
 - Slowed down descent. Retained in upright position.
 - Supplied with stainless steel screws
- for concrete walls.
 - Ref. 510159P and 510159S: bacteriostatic 304 stainless steel tube.
 - Ref. 510159N: high-strength polyamide (Nylon), with 2mm reinforced steel core treated against corrosion.
 - Fixings, secured to wall by a 4mm thick 304 stainless steel plate, concealed by a cover plate.

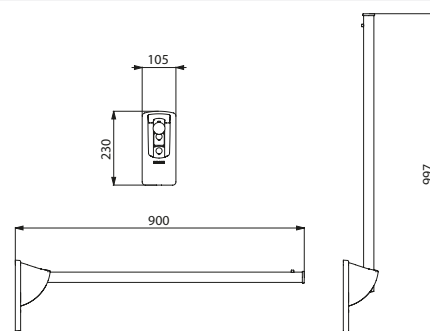

Lift-up shower curtain rail	
Bright polished 304 stainless steel	510159P
Polished satin 304 stainless steel	510159S
HR Nylon bright white	510159N

510159

Ceiling support

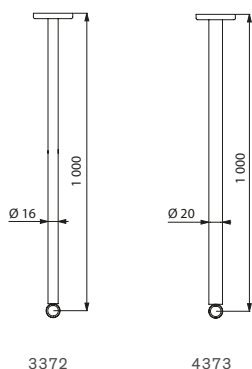

- Removable fixing plate.
- Bright polished 304 stainless steel.
- Can be cut-to-size.
- 1mm thick.
- Length 1m.

Ceiling support	
For curtain rails Ø 16mm	3372
For curtain rails Ø 20mm, concealed fixings	4373

ECO ceiling support

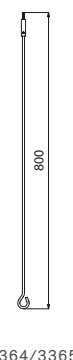

- Bright polished 304 stainless steel and chrome-plated brass.
- Can be cut-to-size.
- Length 800mm.

ECO ceiling support	
For curtain rails Ø 16mm	3364
For curtain rails Ø 20mm	3365

Shower curtain

H. 790mm



- Material: polyester.
- **Bottom of curtain is weighted.**
- Dimensions: L. 880 × H. 790mm.
- Supplied with 6 plastic curtain rings.

Shower curtain H. 790mm, with 6 curtain rings	510158
---	---------------

Shower curtain

H. 1,800mm and 2,000mm



- Material: white PVC.
- Supplied with plastic curtain rings.

Shower curtain - Height 1.8m	
Width 900mm, with 6 curtain rings	381
Width 1,200mm, with 8 curtain rings	382
Width 1,800mm, with 12 curtain rings	387
Shower curtain - Height 2m	
Width 900mm, with 6 curtain rings	1381
Width 1,200mm, with 8 curtain rings	1382
Width 1,800mm, with 12 curtain rings	1386

Curtain rings for shower curtains



- Supplied in packs of 6.

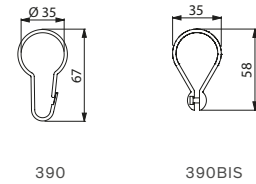

Curtain rings for shower curtains	
Chrome-plated brass, pack of 6	390
Plastic, pack of 6	390BIS

Shower mat



- **Non-slip.**
- White rubber.
- Dimensions: 530 × 530mm.

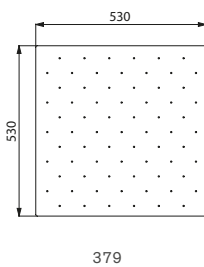

Shower mat	379
------------	------------

Duck-board



- **Non-slip.**
- Semi-rigid, white plastic.
- Can be cut-to-size.
- Dimensions: 22 × 570 × 570mm.

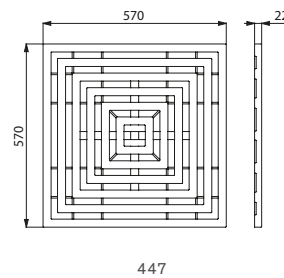

Duck-board	447
------------	------------

ECO robe hooks



- Bright polished 304 stainless steel.
- Dimensions 1 hook: Ø 55mm.
Dimensions 2 hooks: 200 × 43mm.
Dimensions 3 hooks: 300 × 43mm.

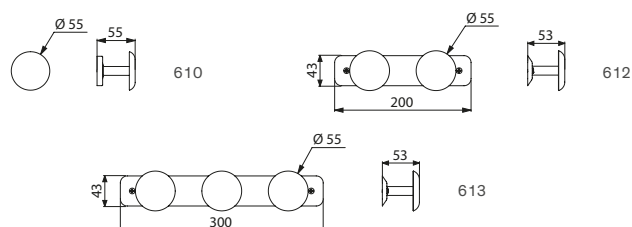

ECO robe hook	
1 hook	610
2 hooks	612
3 hooks	613

Toilet brush set



- Floor-standing and wall-mounted toilet brush set.
- With Nylon brush.
- Dimensions: 145 × 390mm.

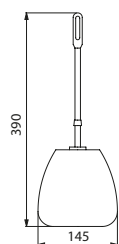

3361

Toilet brush set	
Toilet brush set, with brush	3361
Brush only	3362

Wall-mounted shelf and supports



- Glass shelf with rounded edges, **6mm thick**, 120 × 600mm.
- Chrome-plated shelf supports, length 120mm.



600 + 6555

Basin shelf and supports	
Glass shelf	6555
Chrome-plated supports	600

Toilet roll holder



- Bright polished stainless steel.
- Dimensions: 100 × 134 × 85mm.

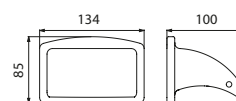

566TER

Toilet roll holder	
	566TER

Toilet paper dispenser

Large ABS model



- White ABS.
- For 400m rolls.
- With lock.
- Level control.
- Dimensions: 120 × 310 × 320mm.

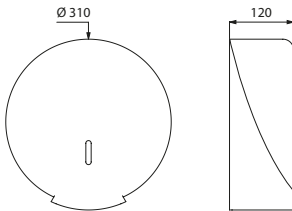

2909

ABS toilet paper dispenser	2909
----------------------------	------

Paper towel dispenser

ABS



- White ABS.
- For folded paper towels.
- With lock.
- Level control.
- Capacity: 500 sheets.
- Dimensions: 115 × 275 × 365mm.

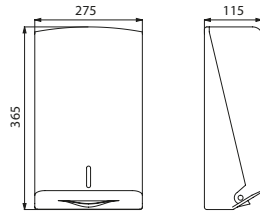

6603D

ABS paper towel dispenser	6603D
Folded paper towels, pack of 160	6606

Paper towel dispenser

Stainless steel



- Polished satin 304 stainless steel.
- With lock and **standard DELABIE key**.
- Level control.
- Capacity: 600 sheets.
- Dimensions: 104 × 285 × 390mm.

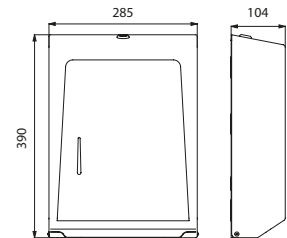

510603S

Stainless steel paper towel dispenser	510603S
---------------------------------------	---------

Liquid soap dispenser

ABS



- White ABS.
- Push button with non-drip system.
- With lock.
- Level control.
- **Capacity: 0.9 litre.**
- Dimensions: 95 × 130 × 235mm.

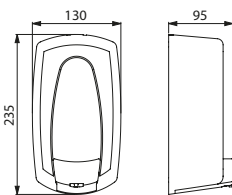

374001

Soap dispenser	374001
----------------	--------

Liquid soap dispenser

ABS, elbow control



- White ABS.
- **With elbow control.**
- Push-button with non-drip system.
- With lock.
- Level control.
- **Capacity: 0.9 litre.**
- Dimensions: 105 × 130 × 215mm.

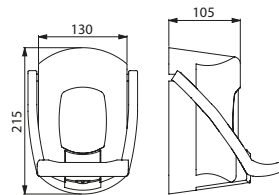

6712

Soap dispenser with elbow control	6712
-----------------------------------	------

Liquid soap dispenser

Stainless steel



- 304 stainless steel.
- One piece.
- With lock.
- Level control.
- Concealed fixings.
- Top-fill articulated flap.
- **Capacity: 1.2 litres.**
- Dimensions: 70 × 125 × 210mm.

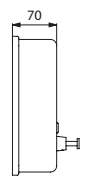
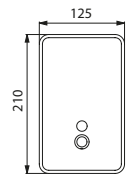

6566/6567

Dispenser, bright polished	6567
Dispenser, polished satin	6566
Valve, spare part	6568
Level control, spare part	6569



Accessibility and Independence

Be-Line® Range

SHOWER SEATS
60



GRAB BARS AND
DROP-DOWN
SUPPORT RAILS
62



SHOWER
GRAB BARS
67



ACCESSORIES
74

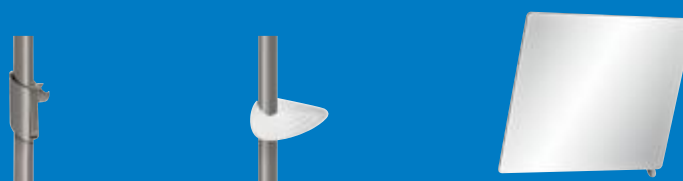







Be-Line® seat **511920W** - Thermostatic mixer **H9741TP** - Be-Line® T-shaped grab bar **511944W**
Be-Line® sliding shower head holder **511911W** - Floor trap **683001** - Be-Line® shelf **511921W**



Be-Line® lift-up shower seat **511920C** - Recessed SECURITHERM sequential thermostatic mixer **790BOX + H9632** - Be-Line® T-shaped grab bar **511944C**
Be-Line® sliding shower head holder **511911C** - Be-Line® soap dish **511912W**



DESIGN, COMFORT, WELL-BEING

Inclusive design

DELABIE's Be-Line® range combines **aesthetics and comfort**.

The innovative design of the Be-Line® grab bars and shower seats eliminates the medical (and sometimes stigmatising) aspects of accessible washrooms, leaving only a feeling of well-being, free from any complex, both at home and in the wider environment.

The Be-Line® range transcends generations and is suitable for every life stage, regardless of age or level of independence, which makes the shared use of sanitary spaces more agreeable for everyone.

Discretion and freedom of movement

The Be-Line® range of grab bars and shower seats, with its clean lines, lack of imposing wall plates, concealed fixings and overall quality, naturally integrates into its environment and heightens the impression of comfort as well as providing the necessary level of discretion.

Since they are closer to the wall, the grab bars require less space. This improves access within the sanitary facilities (showers, WCs, etc.) providing greater freedom of movement and an enhanced feeling of comfort.

Ergonomics

The Be-Line® range of grab bars has a 35mm diameter which provides an **optimum grip** regardless of the product destination or user. The rounded form of these bars, with an **ergonomic, flat front face** that perfectly matches the shape of the hand, **prevents the hand from rotating** and offers greater safety to the user.

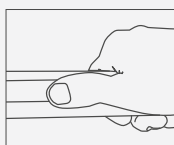

Ergonomics and rotation prevention safety:

allows placement of thumb and perfectly welcomes the shape of the hand.

Two finishes

The Be-Line® range coordinates with all styles and types of materials.

It is available in two aluminium finishes: powder-coated matte white and metallised anthracite. This choice of finish provides, most notably, a **good visual contrast** between the colour of the bars or seats and the walls that they are fixed to.

MAXIMUM HYGIENE

Durable and resistant material

The Be-Line® range of grab bars and shower seats is made from extruded or injection-moulded aluminium, a durable and resistant material.

The smooth, uniform surface is quick and easy to clean, ideal for meeting hygiene requirements.

Fewer seams

Particular attention has been paid to the design of the Be-Line® range to reduce the number of joins and seams. This reduces the build-up of dirt and niches where bacteria can develop, especially on the straight sections which are extruded in one-piece and which have the most frequent contact with hands.

MAXIMUM SAFETY

Tested to over 200kg

In public and commercial places, the user weight is unknown. The products installed must therefore be able to support any user.

10-year warranty

The Be-Line® range of grab bars and shower seats is suitable for intensive use in all types of public or healthcare buildings.

CE marked

DELABIE's Be-Line® range is CE marked and conforms to European Directive 93/42/CEE that relates to medical devices, and complies with European standard EN 12182 "Technical aids for disabled people". This provides an additional guarantee for product users.

38mm safety gap

The elderly or people with reduced mobility can easily lose their balance and fall. Limiting the gap between the Be-line® range of grab bars and the wall to just 38mm prevents the forearm from getting trapped and significantly reduces the risk of fracture.

Robust metal thickness

The thickness of the aluminium used by DELABIE to make the Be-Line® range is significant:

3mm for the tube sections and solid aluminium for the injection-moulded fixing elements.

It is an essential feature that attests to the high quality and strength of these products.

AND ALSO...

100% interchangeable

Be-line® grab bars dimensions are checked during the manufacturing process. There is no need to drill additional holes in the wall if replacing the bar with an identical one.

100% recyclable

Aluminium is 100% recyclable, contributing to sustainable development and protecting the environment.

Complete range

Offering a wide range of products enables DELABIE to respond to the needs and requirements of the accessibility and independence sector. This offering complements DELABIE's other product ranges perfectly.

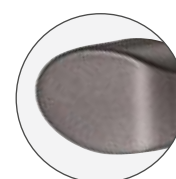

Metallised anthracite



Matte white

ALUMINIUM
Resistant and durable material

INNOVATIVE DESIGN
Suitable for all users
Feeling of well-being

SEAM-FREE
No bacterial niches

2 FINISHES
Coordinates with all styles
Visual contrast



Metallised
anthracite

Matte
white

100% RECYCLABLE

ERGONOMIC FLAT SURFACE
Optimal grip
Safety: prevents hand rotating

TESTED TO OVER 200KG
10-YEAR WARRANTY
CE MARKED

38MM SAFETY GAP
Reduced risk of fracture
Space saving

SOLID ALUMINIUM
Safety

SLIDING 'T'
Adapts to all installations
left or right side

3MM THICK
High resistance

Removable lift-up shower seat

Without leg



- **Large model.**
- Dimensions: 455 × 450 × 90mm.
- Folded dimensions: 85 × 470mm.
- **Removable:** easy to remove with **anti-theft locking** system. Reduces the number of shower seats in a facility, allowing installation only when required e.g. hotels or hospitals providing short-term accommodation for people with reduced mobility.
- **Retained in upright position.**
- **Slowed down descent.**
- Suitable for intensive use in public places or the healthcare sector.
- **Solid, reinforced seat** made from high-strength polymer which can be installed, without a supporting leg, on any suitable wall.
- **Non-slip surface.**
- Choice of powder-coated metallised anthracite or matte white finish; provides a good visual contrast with the wall.
- **Solid aluminium** mounting bracket.
- 5 concealed fixing points.
- Supplied with stainless steel screws Ø 8 × 70mm for concrete walls.
- Tested to over 200kg. Maximum recommended user weight: 135kg.
- 10-year warranty.
- CE marked.

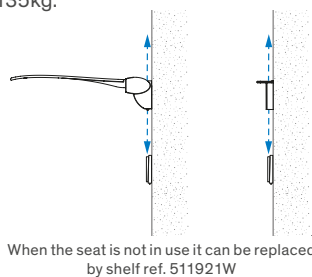
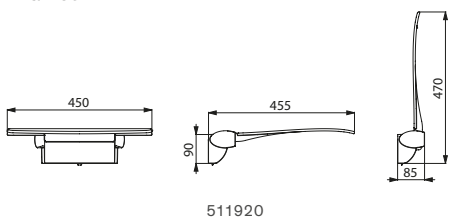

Related product

Wall-mounted shower shelf to conceal bracket



- Dimensions: 55 × 275 × 90mm.
- Conceals the mounting bracket when the lift-up shower seat is removed.
- Reduces the number of lift-up shower seats in a facility, allowing installation only when required e.g. hotels or hospitals providing short-term accommodation for people with reduced mobility.

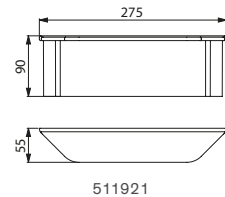

Removable lift-up shower seat	
Metallised anthracite powder-coated aluminium	511920C
Matte white powder-coated aluminium	511920W

Wall-mounted shower shelf to conceal bracket	
Matte white	511921W
Matte white with mounting bracket	511921FW

Removable lift-up shower seat

With leg



- **Large model.**
- Dimensions: 443 × 450 × 480mm.
- Folded dimensions: 87 × 541mm.
- **Removable:** easy to remove with **anti-theft locking** system. Reduces the number of shower seats in a facility, allowing installation only when required e.g. hotels or hospitals providing short-term accommodation for people with reduced mobility.
- **Retained in upright position.**
- **Slowed down descent.**
- Suitable for intensive use in public places or the healthcare sector.
- Solid seat made from high-strength polymer.
- **Non-slip surface.**
- **Reinforced** by a central, hinged **leg**.
- Choice of metallised anthracite or matte white finish; provides a good visual contrast with the wall.
- 5 concealed fixing points.
- Supplied with stainless steel screws Ø 8 × 70mm for concrete walls.
- Tested to over 200kg. Maximum recommended user weight: 135kg.
- 10-year warranty.
- CE marked.

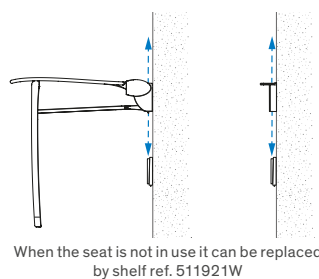
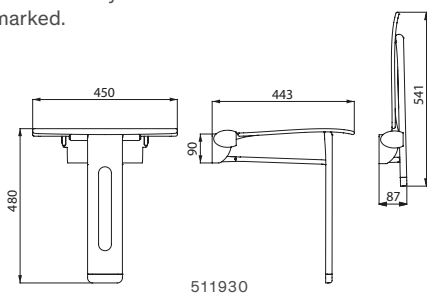

Provisional availability 2nd half 2019. Please contact sales office to check availability.

Removable lift-up shower seat with leg	
Metallised anthracite	511930C
Matte white	511930W

Related product

Wall-mounted shower shelf to conceal bracket



- Dimensions: 55 × 275 × 90mm.
- Conceals the mounting bracket when the lift-up shower seat is removed.
- Reduces the number of lift-up shower seats in a facility, allowing installation only when required e.g. hotels or hospitals providing short-term accommodation for people with reduced mobility.

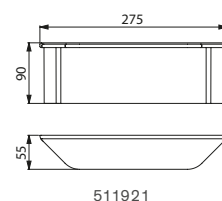

Wall-mounted shower shelf to conceal bracket	
Matte white	511921W
Matte white with mounting bracket	511921FW

Angled grab bar 135°

220 × 220mm



- For WCs, showers or baths.
- For use as a handrail (horizontal part) or as a grab bar (135° part).
- Universal for either left or right side.
- Dimensions: 220 × 220mm.
- Aluminium tube thickness 3mm. Solid aluminium fixing points.
- Rounded profile Ø 35mm with ergonomic flat front face that prevents rotation for an optimal grip.
- Choice of powder-coated metallised anthracite or matte white finish; provides a good visual contrast with the wall.
- Uniform surface for easy maintenance and hygiene.
- 38mm gap between the bar and the wall: minimal space prevents the forearm passing between the bar and the wall, reducing the risk of fracture in case of loss of balance.
- 3 fixing points prevent the hand from getting trapped and simplify installation.
- Concealed fixings.
- Supplied with stainless steel screws Ø 8 × 70mm for concrete walls.
- Tested to over 200kg. Maximum recommended user weight: 135kg.
- 10-year warranty.
- CE marked.

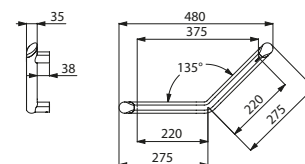

Angled grab bar 135° with 3 fixing points	
Metallised anthracite powder-coated aluminium - 220 × 220mm	511983C
Matte white powder-coated aluminium - 220 × 220mm	511983W

511983

Angled grab bar 135°

400 × 400mm



- For WCs, showers or baths.
- For use as a handrail (horizontal part) or as a grab bar (135° part).
- Universal for either left or right side.
- Dimensions : 400 × 400mm.
- Aluminium tube thickness 3mm. Solid aluminium fixing points.
- Rounded profile Ø 35mm with ergonomic flat front face that prevents rotation for an optimal grip.
- Choice of powder-coated metallised anthracite or matte white finish; provides a good visual contrast with the wall.
- Uniform surface for easy maintenance and hygiene.
- 38mm gap between the bar and the wall: minimal space prevents the forearm passing between the bar and the wall, reducing the risk of fracture in case of loss of balance.
- 3 fixing points prevent the hand from getting trapped and simplify installation.
- Concealed fixings.
- Supplied with stainless steel screws Ø 8 × 70mm for concrete walls.
- Tested to over 200kg. Maximum recommended user weight: 135kg.
- 10-year warranty.
- CE marked.

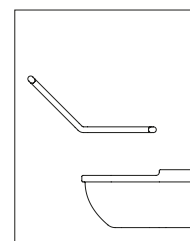

Installation example for WCs

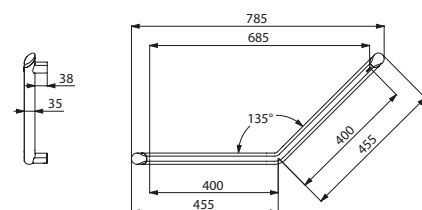

511982

Angled grab bar 135° with 3 fixing points	
Metallised anthracite powder-coated aluminium - 400 × 400mm	511982C
Matte white powder-coated aluminium - 400 × 400mm	511982W



DELABIE

DELABIE

Straight grab bar

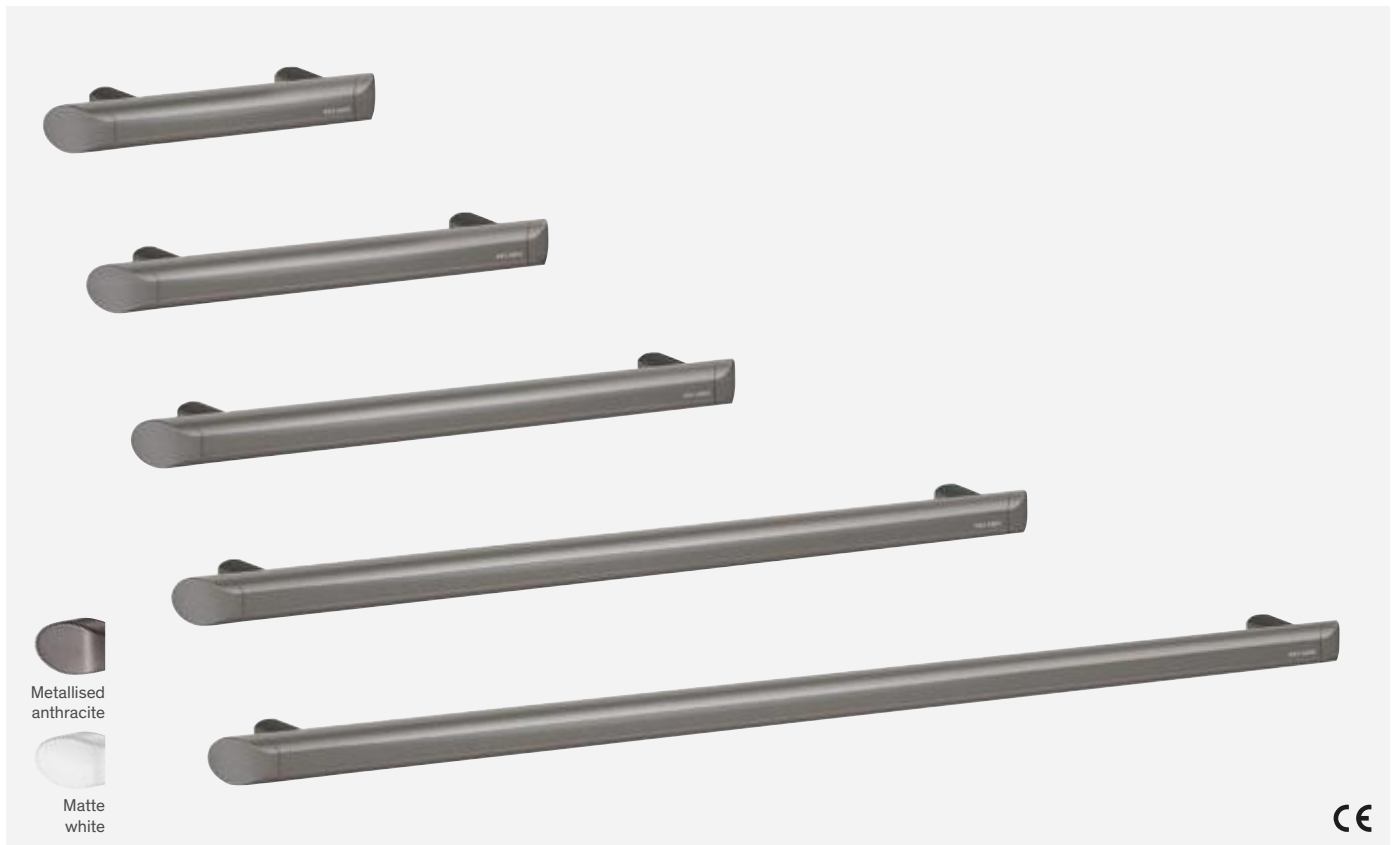

- For WCs, showers or baths.
- For use as a handrail and grab or support bar.
- Dimensions: 300 - 900mm centre-to-centre.
- Aluminium tube thickness 3mm. Solid aluminium fixing points.
- Rounded profile Ø 35mm with ergonomic flat front face that prevents rotation for an optimal grip.
- Choice of powder-coated metallised anthracite or matte white finish; provides a good visual contrast with the wall.
- Uniform surface for easy maintenance and hygiene.
- 38mm gap between the bar and the wall: minimal space prevents the forearm passing between the bar and the wall, reducing the risk of fracture in case of loss of balance.
- Concealed fixings.
- Supplied with stainless steel screws Ø 8 × 70mm for concrete walls.
- Tested to over 200kg. Maximum recommended user weight: 135kg.
- 10-year warranty.
- CE marked.

Straight grab bar - Metallised anthracite	
Metallised anthracite powder-coated aluminium - 300mm	511903C
Metallised anthracite powder-coated aluminium - 400mm	511904C
Metallised anthracite powder-coated aluminium - 500mm	511905C
Metallised anthracite powder-coated aluminium - 600mm	511906C
Metallised anthracite powder-coated aluminium - 900mm	511909C
Straight grab bar - Matte white	
Matte white powder-coated aluminium - 300mm	511903W
Matte white powder-coated aluminium - 400mm	511904W
Matte white powder-coated aluminium - 500mm	511905W
Matte white powder-coated aluminium - 600mm	511906W
Matte white powder-coated aluminium - 900mm	511909W

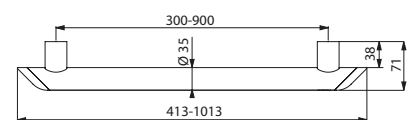

511903/511904/511905/511906/511909

Drop-down support rail



- For WCs or showers.
- Allows side access in the raised position.
- In the lowered position use as a grab bar, as a support for standing and for assisting movement.
- Dimensions: 850 or 650 × 210 × 120mm.
- **Removable:** easy to remove with **anti-theft locking** system. Reduces the number of bars in a facility, allowing installation only when required e.g. hotels or hospitals providing short-term accommodation for people with reduced mobility.
- **Retained in upright position.**
- **Slowed down descent.**
- Aluminium tube.
- Rounded profile Ø 42mm with **ergonomic flat front face that prevents rotation** for an optimal grip.
- Choice of powder-coated metallised anthracite or matte white finish; provides a good visual contrast with the wall.
- Uniform surface for easy maintenance and hygiene.
- Concealed fixings secured to wall by a 304 stainless steel plate, 5mm thick.
- Supplied with stainless steel screws Ø 8 × 70 mm for concrete walls.
- Tested to over 200kg. Maximum recommended user weight: 135kg.
- 10-year warranty.
- CE marked.

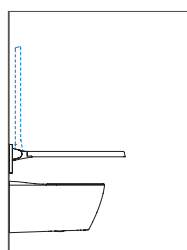

Installation example for WCs

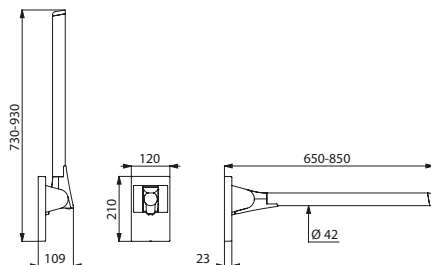

511960/511964

Related product

Cover plate



- Conceals fixing screws when the drop-down rail is removed.
- Reduces the number of drop-down rails in a facility, allowing installation only when required. Example: hotels or hospitals providing short-term accommodation for people with reduced mobility.
- Model with fixing plate: supplied with stainless steel screws for concrete walls.

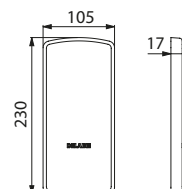

511950

Provisional availability 2nd half 2019. Please contact sales office to check availability.

Please contact sales office to check availability.

Cover without fixing plate	
Metallised anthracite	511950C
Matte white	511950W
Cover with fixing plate	
Metallised anthracite	511950FC
Matte white	511950FW

Straight bar with sliding shower head holder



Additional products



Sliding soap dish (see page 74)

- For showers or baths.
- Can be used as a vertical grab bar and a shower head rail.
- Metallised anthracite or matte white sliding shower head holder with ergonomic grip.
- Sliding soap dish can be added (order separately).
- Height: 1,050mm.
- Aluminium tube thickness 3mm. Solid aluminium fixing points.
- Rounded profile Ø 35mm with ergonomic flat front face that prevents rotation for an optimal grip.
- Choice of powder-coated metallised anthracite or matte white finish; provides a good visual contrast with the wall.
- Uniform surface for easy maintenance and hygiene.
- 38mm gap between the bar and the wall: minimal space prevents the forearm passing between the bar and the wall, reducing the risk of fracture in case of loss of balance.
- Concealed fixings.
- Supplied with stainless steel screws Ø 8 × 70mm for concrete walls.
- Tested to over 200kg. Maximum recommended user weight: 135kg.
- 10-year warranty.
- CE marked.

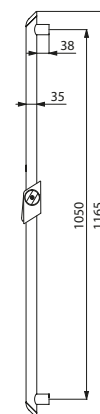

511946

Straight bar with sliding shower head holder	
Metallised anthracite powder-coated aluminium - H. 1,050mm	511946C
Matte white powder-coated aluminium - H. 1,050mm	511946W



Be-Line® lift-up shower seat **511930C** - Be-Line® L-shaped grab bar **511971C** - Be-Line® sliding shower head holder **511911C** - Be-Line® soap dish **511912W**
Recessed SECURITHERM sequential thermostatic mixer **790BOX + H9632**

L-shaped grab bar



Additional products

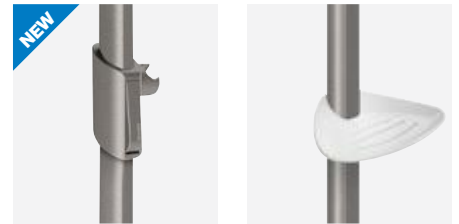

Sliding shower head holder and sliding soap dish
(see page 74)

- For showers or baths.
- Helps the user stand and move safely in the shower or bath.
- Use as a shower rail by adding a sliding shower head holder and/or a soap dish.
- Can be installed with the upright to the left or the right.
- Dimensions: 1,130 or 750 × 450mm.
- Aluminium tube thickness 3mm. Solid aluminium fixing points.
- Rounded profile Ø 35mm with ergonomic flat front face that prevents rotation for an optimal grip.
- Choice of powder-coated metallised anthracite or matte white finish; provides a good visual contrast with the wall.
- Uniform surface for easy maintenance and hygiene.
- 38mm gap between the bar and the wall: minimal space prevents the forearm passing between the bar and the wall, reducing the risk of fracture in case of loss of balance.
- Concealed fixings.
- Supplied with stainless steel screws Ø 8 × 70mm for concrete walls.
- Tested to over 200kg. Maximum recommended user weight: 135kg.
- 10-year warranty.
- CE marked.

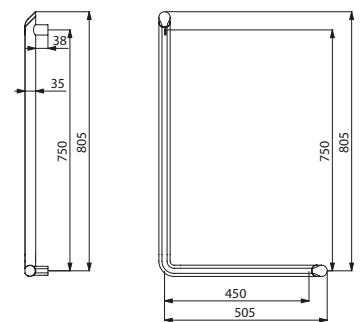

511970

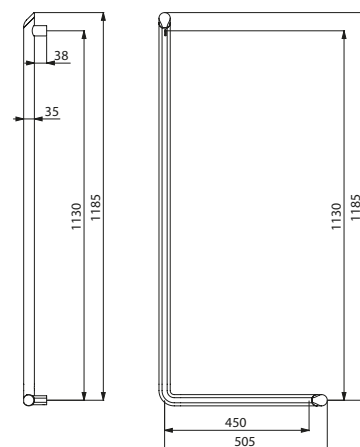

511971

L-shaped grab bar - Metallised anthracite	
Metallised anthracite powder-coated aluminium - H. 750mm	511970C
Metallised anthracite powder-coated aluminium - H. 1,130mm	511971C
L-shaped grab bar - Matte white	
Matte white powder-coated aluminium - H. 750mm	511970W
Matte white powder-coated aluminium - H. 1,130mm	511971W



T-shaped grab bar with sliding vertical bar



Additional products

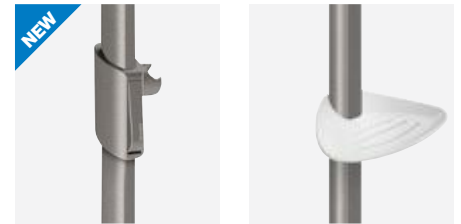

Sliding shower head holder and sliding soap dish
(see page 74)

BE-LINE® RANGE

- **For showers.**
- **Use as a grab bar and to support the user in an upright position.**
- **Helps and secures entry and movement in the shower.**
- **Use as a shower rail by adding a sliding shower head holder and/or a soap dish.**
- **Upright position can be adjusted during installation:** can be moved to the left or the right in order to adapt the space (positioning of shower, depth of shower seat...).
- Dimensions: 1,130 × 500mm.
- Aluminium tube thickness 3mm. Solid aluminium fixing points.
- Rounded profile Ø 35mm **with ergonomic flat front face that prevents rotation** for an optimal grip.
- Choice of powder-coated metallised anthracite or matte white finish; provides a good visual contrast with the wall.
- Uniform surface for easy maintenance and hygiene.
- 38mm gap between the bar and the wall: minimal space prevents the forearm passing between the bar and the wall, reducing the risk of fracture in case of loss of balance.
- Concealed fixings.
- Supplied with stainless steel screws Ø 8 × 70mm for concrete walls.
- Tested to over 200kg. Maximum recommended user weight: 135kg.
- 10-year warranty.
- CE marked.

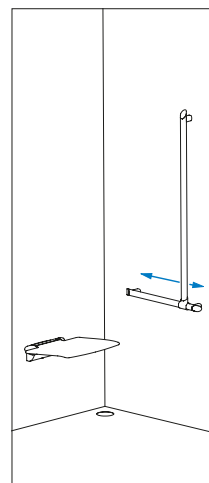

Upright can be moved

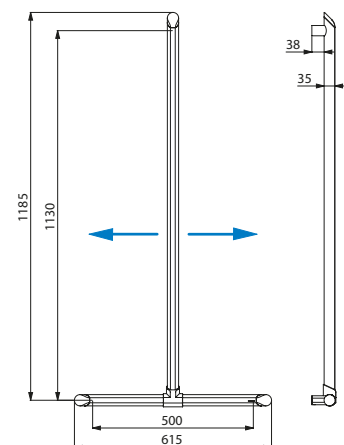

511944

T-shaped grab bar with sliding vertical bar	
Metallised anthracite powder-coated aluminium	511944C
Matte white powder-coated aluminium	511944W

Two-wall corner grab bar



- For WCs, showers or baths.
- Use as a grab bar and to support the user in an upright position.
- Helps and secures entry and movement in the shower also with getting in and out of the bath.
- Helps with the transfer from a wheelchair to the toilet seat for WCs with recessed cisterns or direct flush.
- Dimensions: 695 × 695mm.
- Aluminium tube thickness 3mm. Solid aluminium fixing points.
- Rounded profile Ø 35mm with ergonomic flat front face that prevents rotation for an optimal grip.
- Choice of powder-coated metallised anthracite or matte white finish; provides a good visual contrast with the wall.
- Uniform surface for easy maintenance and hygiene.
- 38mm gap between the bar and the wall: minimal space prevents the forearm passing between the bar and the wall, reducing the risk of fracture in case of loss of balance.
- Concealed fixings.
- Supplied with stainless steel screws Ø 8 × 70mm for concrete walls.
- Tested to over 200kg. Maximum recommended user weight: 135kg.
- 10-year warranty.
- CE marked.

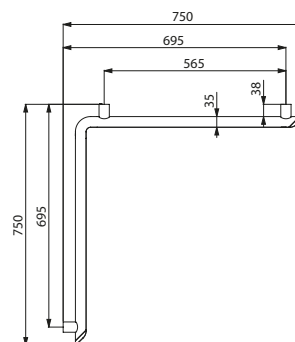

Two-wall corner grab bar	
Metallised anthracite powder-coated aluminium	511941C
Matte white powder-coated aluminium	511941W

511941

Two-wall grab bar with sliding vertical bar



- For showers.
- Use as a grab bar and to support the user in an upright position.
- Helps and secures entry and movement in the shower.
- Use as a shower rail by adding a sliding shower head holder and/or a soap dish.
- Upright position can be adjusted during installation: can be moved to the left or the right in order to adapt the space (positioning of shower, depth of shower seat...).
- Can be installed with the upright on the left or the right.
- Dimensions: 1,130 × 695 × 695mm.
- Aluminium tube thickness 3mm. Solid aluminium fixing points.
- Rounded profile Ø 35mm with ergonomic flat front face that prevents rotation for an optimal grip.
- Choice of powder-coated metallised anthracite or matte white finish; provides a good visual contrast with the wall.
- Uniform surface for easy maintenance and hygiene.
- 38mm gap between the bar and the wall: minimal space prevents the forearm passing between the bar and the wall, reducing the risk of fracture in case of loss of balance.
- Concealed fixings.
- Supplied with stainless steel screws Ø 8 × 70mm for concrete walls.
- Tested to over 200kg. Maximum recommended user weight: 135kg.
- 10-year warranty.
- CE marked.

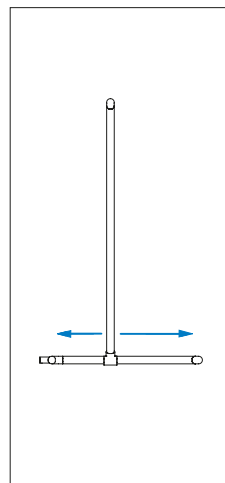

Upright can be moved to the left or the right

Additional products

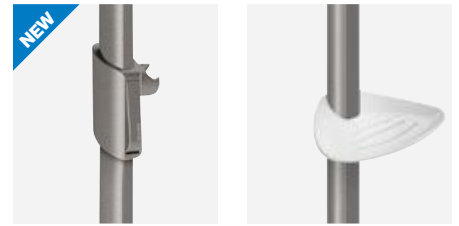

Sliding shower head holder and sliding soap dish (see page 74)

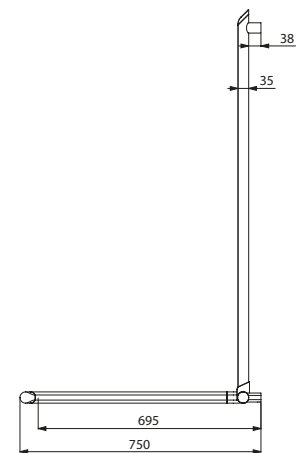

511949

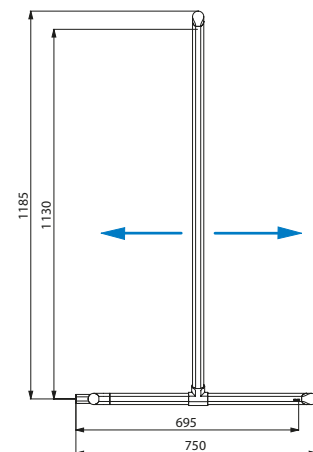

511949

Two-wall grab bar with sliding vertical bar	
Metallised anthracite powder-coated aluminium	511949C
Matte white powder-coated aluminium	511949W

Sliding shower head holder



- Holder for tilting shower head.
- Easy-to-operate ergonomic grip to adjust the height of the shower head holder.
- Slides by using the handle or by pulling on shower hose.

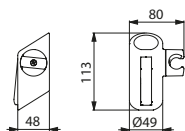

511911

Sliding shower head holder	
Metallised anthracite	511911C
Matte white	511911W

Sliding soap dish



- Soap dish for shower gel or soap.

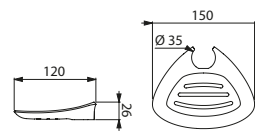

511912W

White sliding soap dish	511912W
-------------------------	---------

Monojet shower head Ø 100mm



- M $\frac{1}{2}$ " shower head in chrome-plated ABS.
- Monojet: rain effect.
- Manual system for removing limescale.

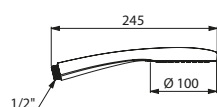

815

Monojet shower head Ø 100mm	815
-----------------------------	-----

SILVER flexible shower hose



- Smooth metal-effect, reinforced food-grade PVC hose for easy maintenance and to reduce bacterial development.
- PVC pipe reinforced in thread polyester conforms to European standard EN 1113.
- Tube interior is made from food-grade PVC.
- Chrome-plated, conical brass connectors $\frac{1}{2}$ ".
- Will withstand strain (50kg), bending and twisting.

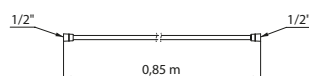

836T3

Flexible shower hose	
L. 0.85m	836T3
L. 1.50m	836T1

Retaining collar for shower head



- **Retaining device:** prevents shower head coming into contact with the floor or floor trap (sources of bacterial niches).
- Fit collar onto shower bar and flexible hose.
- For grab bars Ø 25mm to 35mm.

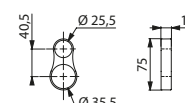

830

Provisional availability 2nd half 2019.
Please contact sales office to check availability.

Retaining collar	830
------------------	-----

Tilting mirror with long, ergonomic lever



- **For combined installation:** can be used from sitting or standing position.
- **Long, ergonomic lever for easy adjustment of mirror angle from a sitting position or from a wheelchair.**
- **Quick and easy to install:** simply clip into place.
- **Anti-theft lock.**
- Bright white HR Nylon lever.
- Mirror made from 6mm Securit safety glass.
- Mirror dimensions: 500 × 600mm.
- Can be tilted up to 20°.

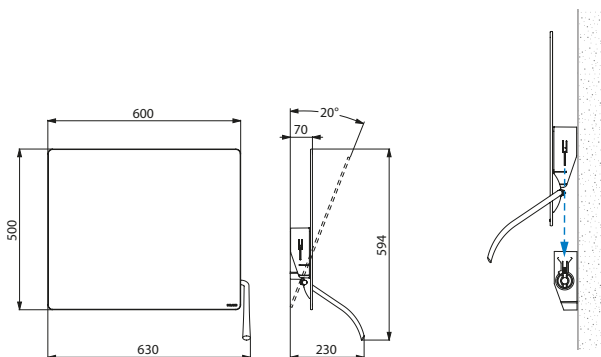

510201N

Tilting mirror with tab handle



- **For combined installation:** can be used from sitting or standing position.
- **Tab handle for easy adjustment of mirror angle for those in a sitting position or for wheelchair users.**
- **Quick and easy to install:** simply clip into place.
- **Anti-theft lock.**
- Mirror made from 6mm Securit safety glass.
- Mirror dimensions: 500 × 600mm.
- Can be tilted up to 20°.

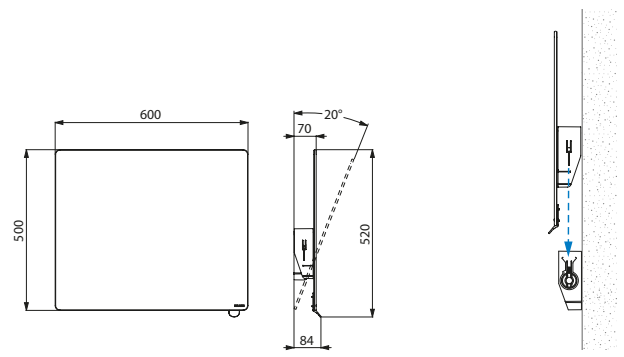

510202

Tilting mirror with long, ergonomic lever	510201N
--	----------------

[For more mirrors and studded pegs see pages 41-43.](#)

Tilting mirror with handle	
Metallised anthracite tab handle	510202C
White Nylon tab handle	510202N

[For more mirrors and studded pegs see pages 41-43.](#)



135° grab bar **5082S** - 700 S WC pan for disabled people **110710** - Backrest **510629S**
TEMPOMATIC electronic flush valve **463150** - Drop-down rail **510164S**

Accessibility and Independence Stainless Steel Range

SHOWER SEATS
81

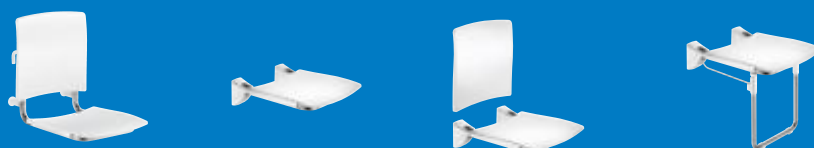

GRAB BARS & DROP-DOWN SUPPORT RAILS
86

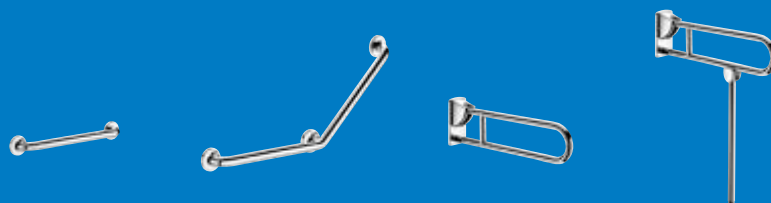

SHOWER GRAB BARS
100

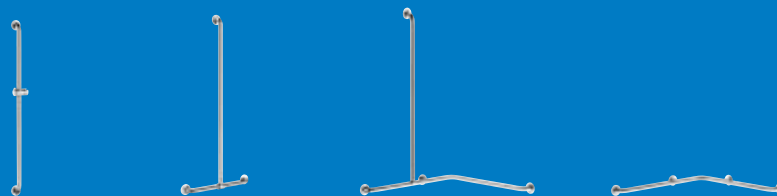

ACCESSORIES
110



STAINLESS STEEL SANITARY WARE
116

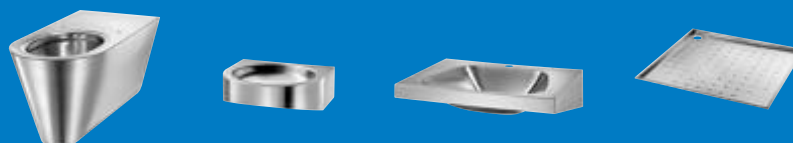



MAXIMUM SAFETY

Tested to over 200kg

In public and commercial places, the user weight is unknown. The products installed must therefore be able to support any user.

10-year warranty

DELABIE's grab bars and shower seats are suitable for intensive use in all types of public or healthcare buildings.

Stainless steel is a noble metal alloy (chrome, nickel and steel) which has no surface treatments, so if it gets scratched or cut there is **no risk of rust appearing**. DELABIE's stainless steel products remain in perfect condition throughout their lifespan.

CE marked

DELABIE's grab bars and shower seats are CE marked and conform to European Directive 93/42/CEE that relates to medical devices, and complies with European standard EN 12182 "Technical aids for disabled people". This provides an additional guarantee for product users.

40mm safety gap

The elderly or people with reduced mobility can easily lose their balance and fall. Limiting the gap between the bar and the wall to just 40mm prevents the forearm from getting trapped and significantly reduces the risk of fracture.

Since they are closer to the wall, the grab bars require less space. This improves access within the sanitary facilities (showers, WCs, etc.) providing greater freedom of movement. The grab bars are also more discreet.

Optimised grip

The diameter of the grab bars available ensures an optimum grip regardless of the end-use of the products. For healthcare facilities or public buildings we recommend grab bars with a diameter of 32mm.

Tube thickness

The tubes used by DELABIE are generally thicker than most products available. It is an essential feature that attests to the high quality and strength of these products.

DELABIE's bead weld by "ArN-Securit"

The plate and tube are welded together using a bead weld so there is no need for a filler material (a process exclusive to "ArN-Securit"). The plate and the tube form a single, integrated structure particularly resistant to the mechanical stresses placed on grab bars.

Bending tubes with a mandrel

The tubes are bent with precision using a mandrel to prevent the metal from ovalising or stretching, ensuring a uniform thickness of the metal throughout the bend.

Concealed fixings

All fixings are concealed by a stainless steel cover plate.

MAXIMUM HYGIENE

Stainless Steel: a material that limits bacterial proliferation

DELABIE's grab bars are made from bacteriostatic 304 stainless steel. With this type of stainless steel, a thin, invisible protective layer forms continuously when in contact with air or water.

Even if the surface is damaged mechanically, the stainless steel is protected against corrosion.

The surface remains bright, hard and smooth, preventing bacteria from easily adhering to the surface.

Bacterial development is therefore slower compared to other materials.

Studies have regularly proven the aseptic qualities of stainless steel. It is ideal for environments that demand high standards of hygiene (for example hospitals, retirement homes, schools and canteens).

“Stainless steel cannot be overlooked when it comes to hygiene.”

DELABIE's UltraPolish and UltraSatin finishes: cleaning is easy and sustainable

Using surfaces that are easy to clean and disinfect reduces the risk of nosocomial infection. DELABIE's **UltraPolish** bright polished finish and **UltraSatin** satin polished finish provide the grab bars with a uniform, non-porous surface. They are easy to clean and require less cleaning product. Bacterial retention after cleaning is extremely low, up to 20 times less than for other materials such as glass or plastic.

Studies show that after several cycles of daily soiling and cleaning, polished stainless steel retains less dirt and fewer residual bacteria than copper which also has bactericidal properties. Copper surfaces degrade over time, making them more difficult to clean. Polished stainless steel provides better hygiene by facilitating sustainable cleaning.

Fewer seams

Particular attention has been paid to the design of the grab bar and shower seats to reduce the number of joints and seams. This reduces the build-up of dirt and niches where bacteria can develop.

AND ALSO...

100% interchangeable

The fixing plates for the bars are indexed and the dimensions are checked during the manufacturing process. There is no need to drill additional holes in the wall if replacing the bar with an identical one.

100% recyclable

Stainless steel is 100% recyclable, contributing to sustainable development and protecting the environment.

DELABIE's stainless steel products contain 50-65% recycled stainless steel.

Complete range

Offering a wide range of products enables DELABIE to respond to the needs and requirements of the accessibility and independence sector. This offering complements DELABIE's other product ranges perfectly.

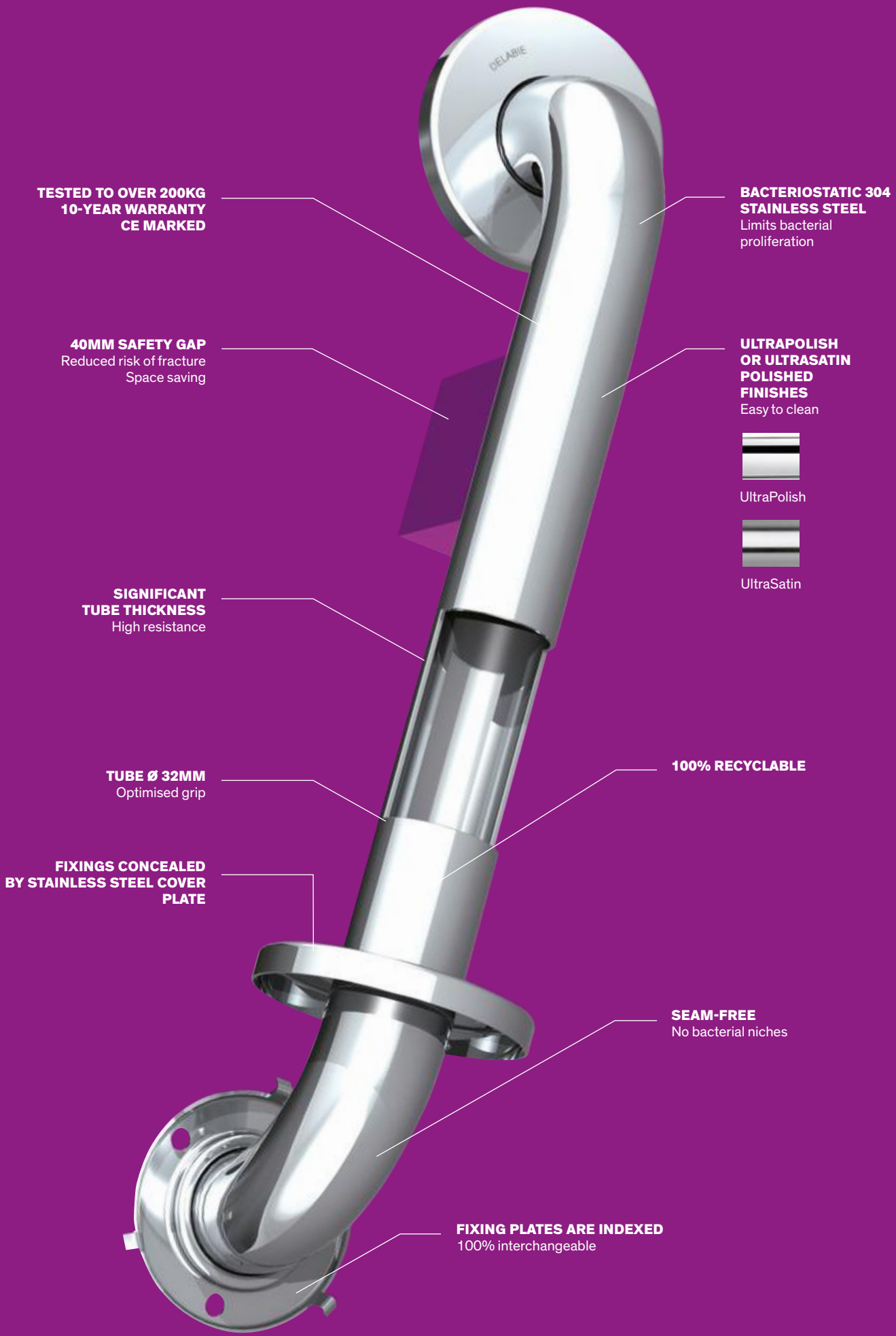

TESTED TO OVER 200KG
10-YEAR WARRANTY
CE MARKED

40MM SAFETY GAP
Reduced risk of fracture
Space saving

SIGNIFICANT TUBE THICKNESS
High resistance

TUBE Ø 32MM
Optimised grip

FIXINGS CONCEALED BY STAINLESS STEEL COVER PLATE

FIXING PLATES ARE INDEXED
100% interchangeable

BACTERIOSTATIC 304 STAINLESS STEEL
Limits bacterial proliferation

ULTRAPOLISH OR ULTRASATIN POLISHED FINISHES
Easy to clean



UltraPolish



UltraSatin

100% RECYCLABLE

SEAM-FREE
No bacterial niches



Removable shower seat

To hang on grab bars



UltraPolish bright polished stainless steel structure



UltraSatin polished satin stainless steel structure

ACCESSIBILITY
STAINLESS STEEL

- **HR Comfort shower seat and backrest.**
- **Large model.**
- To hang on grab bars Ø 32mm (see refs. 5481, 5120 and 50505 pages 106-109).
- **Removable:** reduces the number of shower seats in a facility, allowing installation only when required e.g. hotels or hospitals providing short-term accommodation for people with reduced mobility.
- Dimensions: 590 × 420 × 510mm.
- Suitable for intensive use in public places or the healthcare sector.
- Detachable solid seat made from high-strength polymer.
- Uniform non-porous surface for easy maintenance and hygiene.
- Good resistance to chemical products and cleaning.
- Anti-UV treatment.
- Warm to the touch.
- Bacteriostatic 304 stainless steel structure Ø 32mm.
- **Adjustable screw jacks guarantee a good horizontal position.**
- **Large protective caps prevent damage to the wall.**
- Tested to over 200kg. Maximum recommended user weight: 135kg.
- 10-year warranty.
- CE marked.

Removable Comfort shower seat to hang on grab bars	
UltraPolish bright polished stainless steel structure	510300
UltraSatin polished satin stainless steel structure	510300S
White powder-coated stainless steel structure	510300N

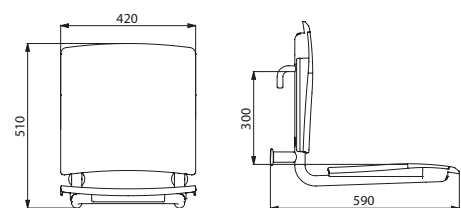

510300

Lift-up shower seat



- **HR Comfort shower seat and backrest.**
- **Large model.**
- Dimensions: 506 × 420 × 620mm.
- Folded dimensions: 120 × 620mm.
- **Retained in upright position.**
- **Slowed down descent.**
- Suitable for intensive use in public places or the healthcare sector.
- Detachable solid seat made from high-strength polymer.
- Uniform non-porous surface for easy maintenance and hygiene.
- Good resistance to chemical products and cleaning.
- Anti-UV treatment.
- Warm to the touch.
- Bacteriostatic 304 stainless steel structure Ø 32mm.
- Concealed fixings secured to wall by a 304 stainless steel plate, 4mm thick.
- Supplied with stainless steel screws for concrete walls.
- Tested to over 200kg. Maximum recommended user weight: 135kg.
- 10-year warranty.
- CE marked.



HR Comfort backrest

- For shower seats refs. 510420, 510420N, 510430 and 510430N.
- Dimensions: 56 × 420 × 410mm.
- Detachable solid backrest made from high-strength polymer.



HR Comfort shower seat

- Dimensions: 506 × 420 × 138mm.
- Folded dimensions: 95 × 540mm.

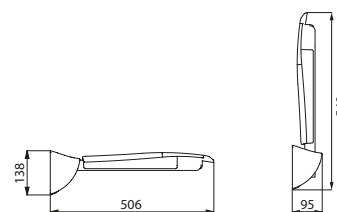

510420

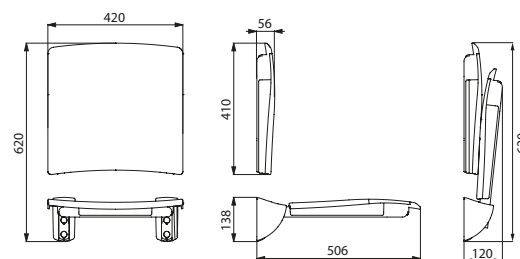

510434

Lift-up Comfort shower seat - UltraPolish bright polished stainless steel structure	
Shower seat only	510420
Backrest only	510429
Shower seat with backrest	510434
Lift-up Comfort shower seat - UltraSatin polished satin stainless steel structure	
Shower seat only	510420S
Backrest only	510429S
Shower seat with backrest	510434S
Lift-up Comfort shower seat - White powder-coated stainless steel structure	
Shower seat only	510420N
Backrest only	510429N
Shower seat with backrest	510434N

Lift-up shower seat with leg



- **HR Comfort shower seat and backrest.**
- **Large model.**
- Dimensions: 506 × 420 × 1,000mm.
- Folded dimensions: 165 × 620mm.
- **Retained in upright position.**
- **Slowed down descent.**
- Suitable for intensive use in public places or the healthcare sector.
- Detachable solid seat made from high-strength polymer.
- Uniform non-porous surface for easy maintenance and hygiene.
- Good resistance to chemical products and cleaning.
- Anti-UV treatment.
- Warm to the touch.
- Bacteriostatic 304 stainless steel structure Ø 32mm.
- **Reinforced by a folding, articulated leg** made from 304 stainless steel tube Ø 25mm.
- Concealed fixings secured to wall by a 304 stainless steel plate, 4mm thick.
- Supplied with stainless steel screws for concrete walls.
- **Tested to over 300kg. Maximum recommended user weight: 170kg.**
- 10-year warranty. CE marked.



HR Comfort backrest

- For shower seats refs. 510420, 510420N, 510430 and 510430N.
- Dimensions: 56 × 420 × 410mm.
- Detachable solid backrest made from high-strength polymer.



HR Comfort shower seat with leg

- Dimensions: 506 × 420 × 480mm.
- Folded dimensions: 130 × 540mm.

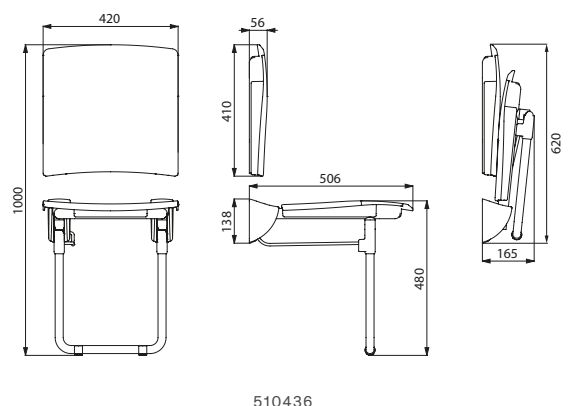
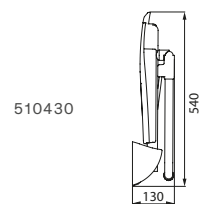

Lift-up Comfort shower seat with leg - UltraPolish bright polished stainless steel structure	
Shower seat with leg only	510430
Backrest only	510429
Shower seat with leg and backrest	510436
Lift-up Comfort shower seat with leg - UltraSatin polished satin stainless steel structure	
Shower seat with leg only	510430S
Backrest only	510429S
Shower seat with leg and backrest	510436S
Lift-up Comfort shower seat with leg - White powder-coated stainless steel structure	
Shower seat with leg only	510430N
Backrest only	510429N
Shower seat with leg and backrest	510436N

Removable shower seat

To hang on grab bars



- To hang on grab bars Ø 32mm (see refs. 5481, 5120 and 50505 pages 106-109).
- **Large model** dimensions: 490 - 505 × 420 × 470mm.
- **Standard model** dimensions: 490 - 505 × 340 × 470mm.
- White plastic slats.
- Structure made from bacteriostatic 304 stainless steel tube Ø 25mm.
- UltraPolish bright polished stainless steel finish, uniform non-porous surface for easy maintenance and hygiene.
- **Adjustable screw jacks guarantee a good horizontal position.**
- Rubber protective caps on the screw jacks.
- Tested to over 200kg. Maximum recommended user weight: 135kg.

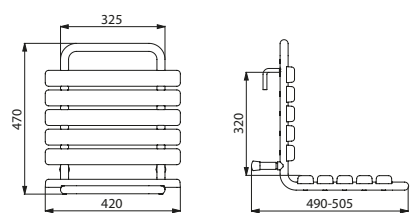

393

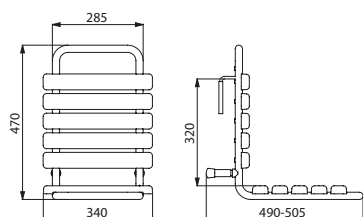

395

Removable slatted seat to hang on grab bars	
Large model	393
Standard model	395

Lift-up shower seat



- **Large model** dimensions: 380 × 420 × 180mm.
- **Standard model** dimensions: 380 × 340 × 180mm.
- Folded dimensions: 110 × 445mm.
- White plastic slats.
- **6 fixing points.**
- Tested to over 200kg. Maximum recommended user weight: 135kg.

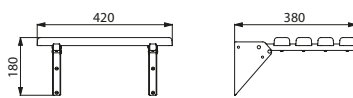

437

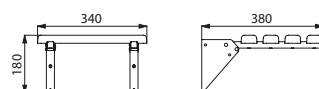

423

Lift-up slatted seat	
Large model	437
Standard model	423

Lift-up shower seat with leg



- **Large model** dimensions: 380 × 420 × 480mm.
- **Standard model** dimensions: 380 × 340 × 480mm.
- Folded dimensions: 110 × 470mm.
- Seat height: 480mm.
- White plastic slats.
- **Reinforced by a folding, articulated leg** made from stainless steel tube Ø 20mm.
- **6 fixing points.**
- Tested to over 200kg. Maximum recommended user weight: 135kg.

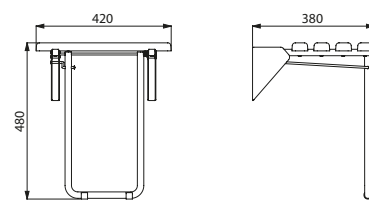

438

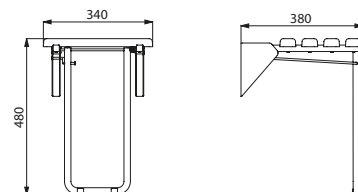

431

Lift-up slatted seat with leg	
Large model	438
Standard model	431



Straight grab bar

Tube Ø 25mm

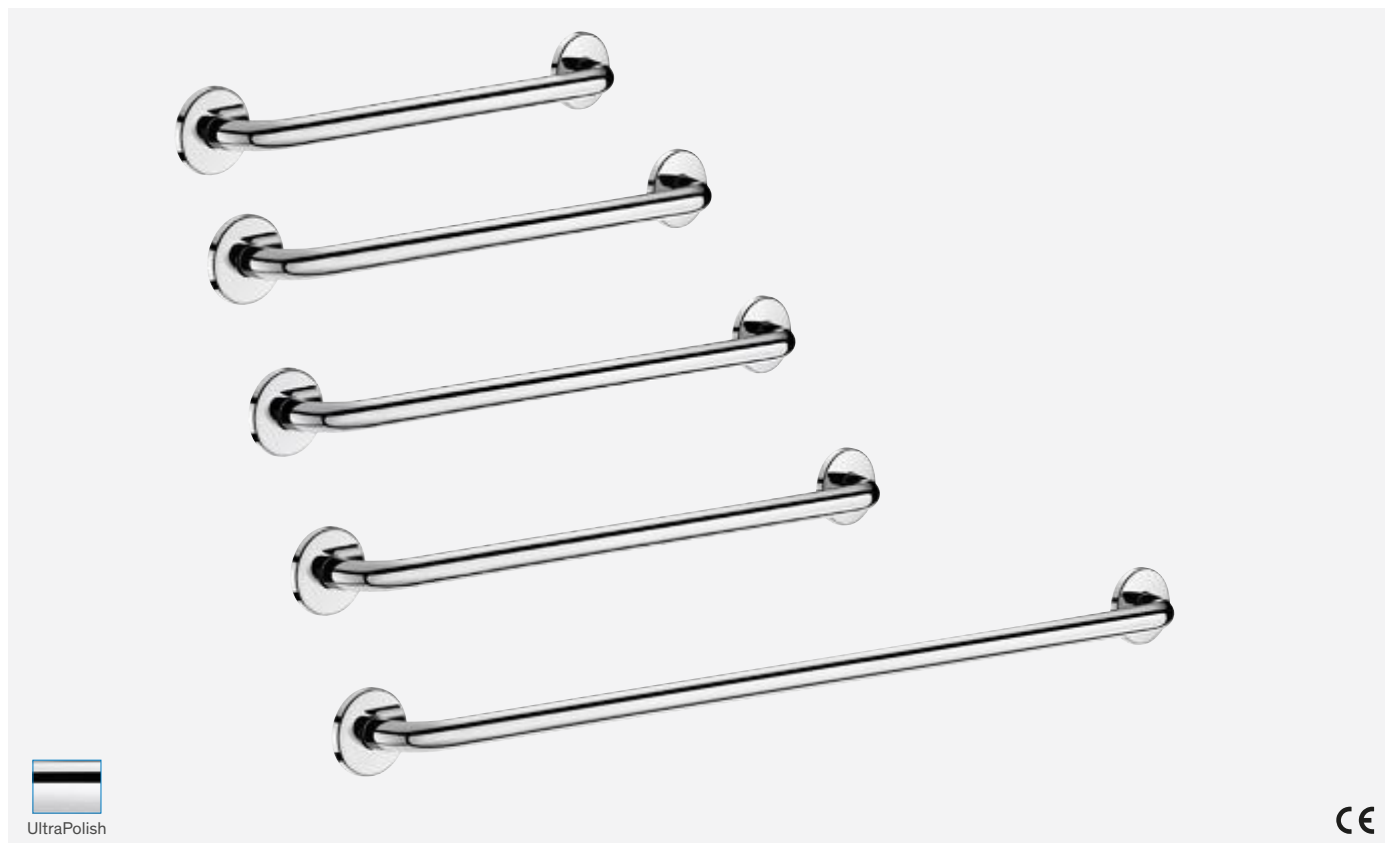

- For WCs, showers or baths.
- For use as a handrail and grab or support bar.
- Dimensions: 300 - 900mm centre-to-centre, Ø 25mm.
- Bacteriostatic 304 stainless steel tube.
- Stainless steel with UltraPolish bright polished finish, uniform non-porous surface for easy maintenance and hygiene.
- Plate welded to the tube by invisible safety bead weld (process exclusive to "ArN-Securit").
- 40mm gap between the bar and the wall: minimal space prevents the forearm passing between the bar and the wall, reducing the risk of fracture in case of loss of balance.
- Concealed fixings secured to wall by a 3-hole fixing plate, Ø 72mm. Fixing plates and cover plates in 304 stainless steel.
- Supplied with stainless steel screws for concrete walls.
- Tested to over 200kg. Maximum recommended user weight: 115kg.
- 10-year warranty.
- CE marked.

Straight grab bar Ø 25mm - UltraPolish	
UltraPolish bright polished stainless steel - 300mm	5055P2
UltraPolish bright polished stainless steel - 400mm	5056P2
UltraPolish bright polished stainless steel - 500mm	5057P2
UltraPolish bright polished stainless steel - 600mm	5058P2
UltraPolish bright polished stainless steel - 900mm	5059P2

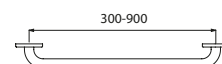
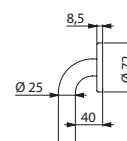

5055P2/5056P2/5057P2/5058P2/5059P2

Straight grab bar

Tube \varnothing 32mm

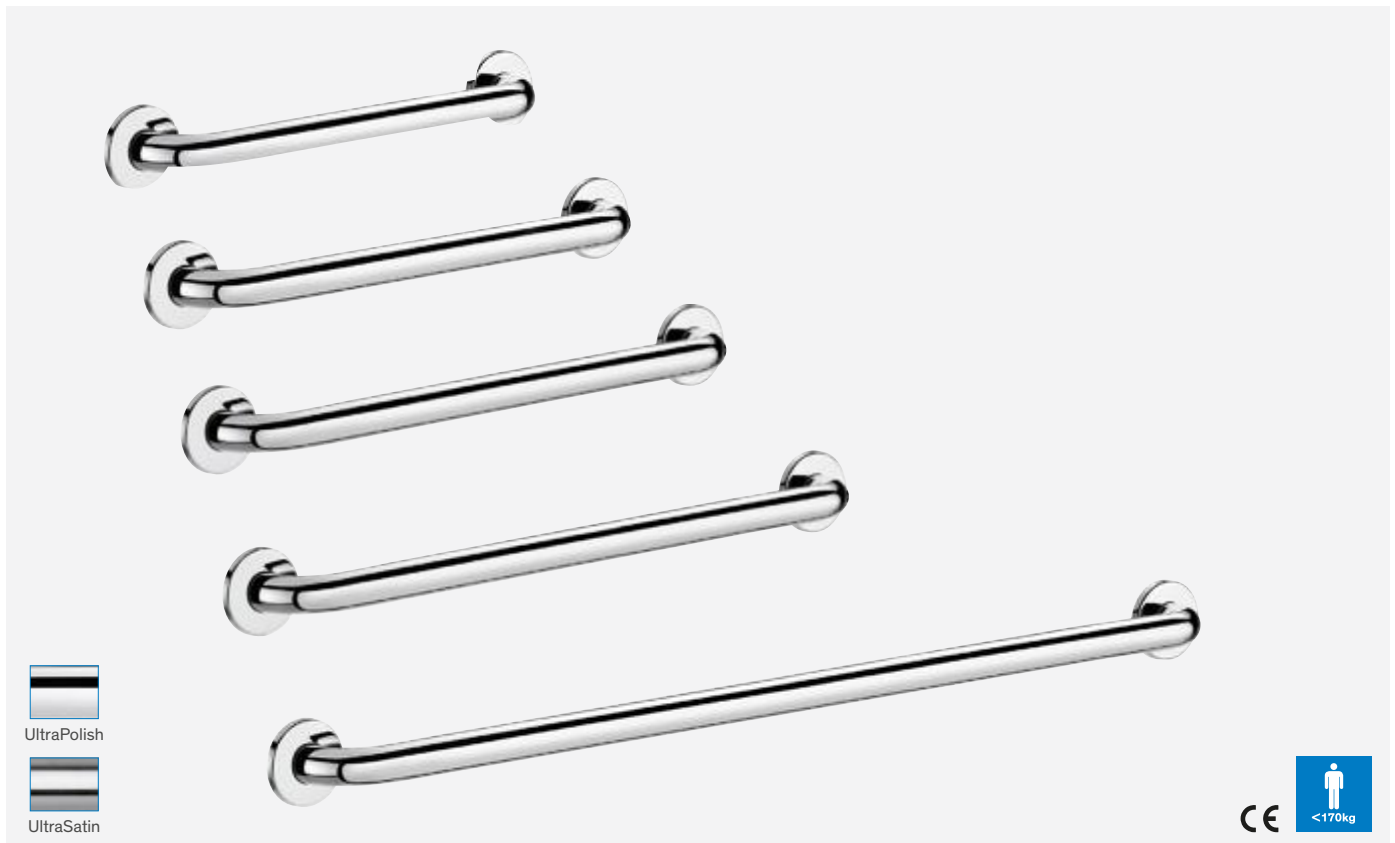

- For WCs, showers or baths.
- For use as a handrail and grab or support bar.
- Dimensions: 300 - 900mm centre-to-centre, \varnothing 32mm.
- Bacteriostatic 304 stainless steel tube.
- Stainless steel with UltraPolish bright polished finish or UltraSatin polished satin finish, uniform non-porous surface for easy maintenance and hygiene.
- Plate welded to the tube by invisible safety bead weld (process exclusive to "ArN-Securit").
- 40mm gap between the bar and the wall: minimal space prevents the forearm passing between the bar and the wall, reducing the risk of fracture in case of loss of balance.
- Concealed fixings secured to wall by a 3-hole fixing plate, \varnothing 72mm. Fixing plates and cover plates in 304 stainless steel.
- Supplied with stainless steel screws for concrete walls.
- **Tested to over 250kg. Maximum recommended user weight: 170kg** (900mm model: tested to over 200kg, maximum recommended user weight: 135kg).
- 10-year warranty.
- CE marked.

Straight grab bar \varnothing 32mm - UltraPolish	
UltraPolish bright polished stainless steel - 300mm	5050P2
UltraPolish bright polished stainless steel - 400mm	50504P2
UltraPolish bright polished stainless steel - 500mm	50505P2
UltraPolish bright polished stainless steel - 600mm	50506P2
UltraPolish bright polished stainless steel - 900mm	50509P2
Straight grab bar \varnothing 32mm - UltraSatin	
UltraSatin polished satin stainless steel - 300mm	5050S
UltraSatin polished satin stainless steel - 400mm	50504S
UltraSatin polished satin stainless steel - 500mm	50505S
UltraSatin polished satin stainless steel - 600mm	50506S
UltraSatin polished satin stainless steel - 900mm	50509S

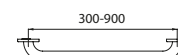
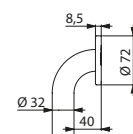

5050/50504/50505/50506/50509

ACCESSIBILITY
STAINLESS STEEL

Angled grab bar 135°
2 fixing points



- For WCs, showers or baths.
- For use as a handrail (horizontal part) or as a grab bar (135° part).
- Universal for either left or right side.
- Dimensions: 400 × 400mm or 220 × 220mm.
- Bacteriostatic 304 stainless steel tube.
- Stainless steel with UltraPolish bright polished finish or UltraSatin polished satin finish, uniform non-porous surface for easy maintenance and hygiene.
- Plate welded to the tube by invisible safety bead weld (process exclusive to "ArN-Securit").
- 40mm gap between the bar and the wall: minimal space prevents the forearm passing between the bar and the wall, reducing the risk of fracture in case of loss of balance.
- Concealed fixings secured to wall by a 3-hole fixing plate, Ø 72mm. Fixing plates and cover plates in 304 stainless steel.
- Supplied with stainless steel screws for concrete walls.
- Tested to over 200kg. Maximum recommended user weight: 135kg for Ø 32mm and 115kg for Ø 25mm.
- 10-year warranty.
- CE marked.

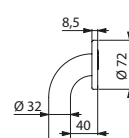

5081/5083

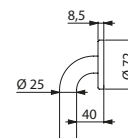

5086

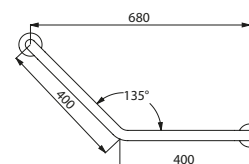

5081/5086

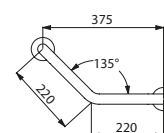

5083

Angled grab bar 135° 2 fixing points - Ø 32mm	
UltraPolish bright polished stainless steel - 400 × 400mm	5081P2
UltraPolish bright polished stainless steel - 220 × 220mm	5083P
UltraSatin polished satin stainless steel - 400 × 400mm	5081S
UltraSatin polished satin stainless steel - 220 × 220mm	5083S
Angled grab bar 135° 2 fixing points - Ø 25mm	
UltraPolish bright polished stainless steel - 400 × 400mm	5086P2

Angled grab bar 135° 3 fixing points



ACCESSIBILITY
STAINLESS STEEL

- For WCs, showers or baths.
- For use as a handrail (horizontal part) or as a grab bar (135° part).
- Universal for either left or right side.
- Dimensions: 400 × 400mm.
- Bacteriostatic 304 stainless steel tube.
- Stainless steel with UltraPolish bright polished finish or UltraSatin polished satin finish, uniform non-porous surface for easy maintenance and hygiene.
- Plate welded to the tube by invisible safety bead weld (process exclusive to "ArN-Securit").
- 40mm gap between the bar and the wall: minimal space prevents the forearm passing between the bar and the wall, reducing the risk of fracture in case of loss of balance.
- **3 fixing points prevent the hand from getting trapped and simplify installation.**
- Concealed fixings secured to wall by a 3-hole fixing plate, Ø 72mm. Fixing plates and cover plates in 304 stainless steel.
- Supplied with stainless steel screws for concrete walls.
- **Tested to over 250kg. Maximum recommended user weight: 170kg** (Ø 25mm model: tested to over 200kg, maximum recommended user weight: 115kg).
- 10-year warranty.
- CE marked.

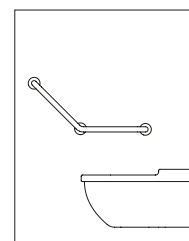

Installation example
for WCs

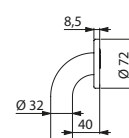

5082

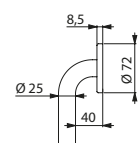

5087

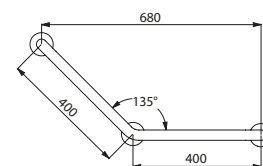

5082/5087

Angled grab bar 135° 3 fixing points - Ø 32mm	
UltraPolish bright polished stainless steel - 400 × 400mm	5082P
UltraSatin polished satin stainless steel - 400 × 400mm	5082S
White powder-coated stainless steel - 400 × 400mm	5082W
Angled grab bar 135° 3 fixing points - Ø 25mm	
UltraPolish bright polished stainless steel - 400 × 400mm	5087P

Angled grab bar 90°



- For WCs or baths.
- For use as a handrail (horizontal part) or as a grab bar (vertical part).
- Universal for either left or right side.
- Dimensions: 300 × 300mm, Ø 32mm.
- Bacteriostatic 304 stainless steel tube.
- Stainless steel with UltraPolish bright polished finish or UltraSatin polished satin finish, uniform non-porous surface for easy maintenance and hygiene.
- Plate welded to the tube by invisible safety bead weld (process exclusive to "ArN-Securit").
- 40mm gap between the bar and the wall: minimal space prevents the forearm passing between the bar and the wall, reducing the risk of fracture in case of loss of balance.
- Concealed fixings secured to wall by a 3-hole fixing plate, Ø 72mm. Fixing plates and cover plates in 304 stainless steel.
- Supplied with stainless steel screws for concrete walls.
- Tested to over 200kg. Maximum recommended user weight: 135kg.
- 10-year warranty.
- CE marked.

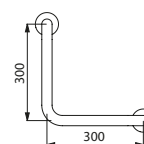
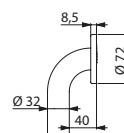

Angled grab bar 90° Ø 32mm	
UltraPolish bright polished stainless steel	5180P2
UltraSatin polished satin stainless steel	5180S

5180

Angled grab bar 45°

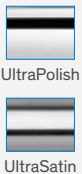

UltraPolish

UltraSatin

CE

- For WCs or baths.
- For use as a handrail (horizontal part) or as a grab bar (45° part).
- Dimensions: 480 × 320mm, Ø 32mm.
- Bacteriostatic 304 stainless steel tube.
- Stainless steel with UltraPolish bright polished finish or UltraSatin polished satin finish, uniform non-porous surface for easy maintenance and hygiene.
- Plate welded to the tube by invisible safety bead weld (process exclusive to "ArN-Securit").
- 40mm gap between the bar and the wall: minimal space prevents the forearm passing between the bar and the wall, reducing the risk of fracture in case of loss of balance.
- Concealed fixings secured to wall by a 3-hole fixing plate, Ø 72mm. Fixing plates and cover plates in 304 stainless steel.
- Supplied with stainless steel screws for concrete walls.
- Tested to over 200kg. Maximum recommended user weight: 135kg.
- 10-year warranty.
- CE marked.

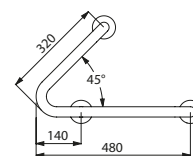
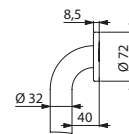

Left model - 5181G

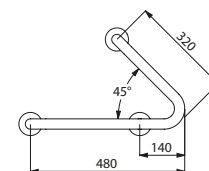

Right model - 5181D

Angled grab bar 45° Ø 32mm - UltraPolish	
UltraPolish bright polished stainless steel - Left model	5181GP2
UltraPolish bright polished stainless steel - Right model	5181DP2
Angled grab bar 45° Ø 32mm - UltraSatin	
UltraSatin polished satin stainless steel - Left model	5181GS
UltraSatin polished satin stainless steel - Right model	5181DS



135° grab bar **5082S** - 700 SWC pan for disabled people **110710** - TEMPOMATIC electronic direct flush valve **463150** - Drop-down rail **510164S**

Drop-down support rail with concealed fixings

Without leg

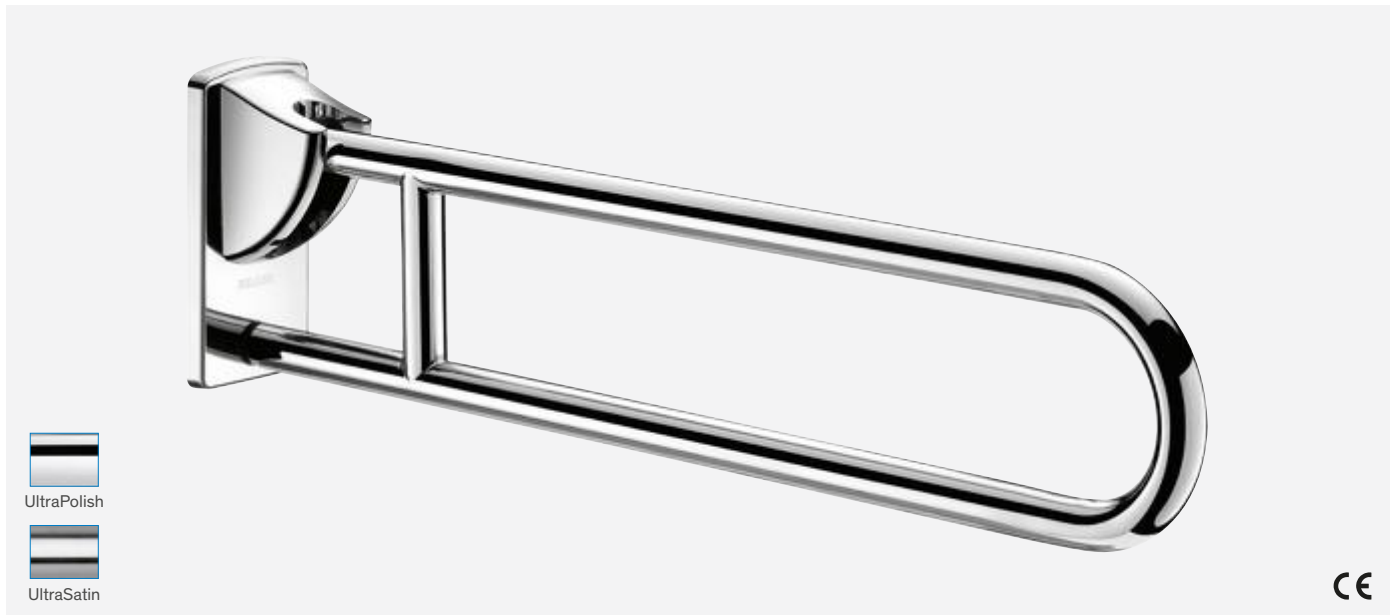

- For WCs or showers.
- Allows side access in the raised position.
- In the lowered position use as a grab bar, as a support for standing and for assisting movement.
- Dimensions: 850 or 650 × 230 × 105mm, Ø 32mm.
- Retained in upright position.
- Slowed down descent.
- Bacteriostatic 304 stainless steel tube.
- Stainless steel with UltraPolish bright polished finish or UltraSatin polished satin finish, uniform non-porous surface for easy maintenance and hygiene.
- Concealed fixings secured to wall by a 304 stainless steel plate, 4mm thick.
- Supplied with stainless steel screws for concrete walls.
- Tested to over 200kg. Maximum recommended user weight: 135kg.
- 10-year warranty.
- CE marked.

Additional products



Backrest for WCs and toilet roll holder (see page 112)

Related product



- Cover plate**
- Conceals the fixing screws when the drop-down support rail is removed.
 - Reduces the number of rails in a facility, allowing installation only when required e.g. hotels or hospitals accommodating a disabled person temporarily.
 - Supplied with stainless steel screws for concrete walls.

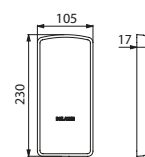

510150

Chrome-plated cover with fixing plate

510150

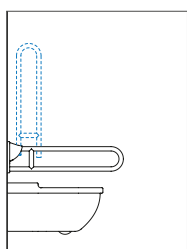

Installation example for WCs

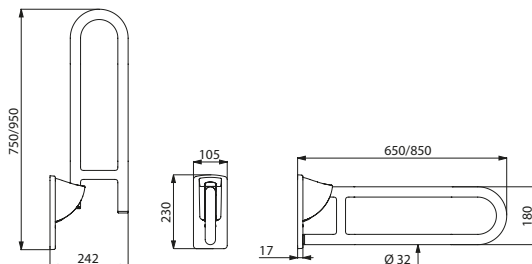

510160/510164

Drop-down support rail with concealed fixings Ø 32mm - UltraPolish	
UltraPolish bright polished stainless steel - L. 650mm	510160P
UltraPolish bright polished stainless steel - L. 850mm	510164P
Drop-down support rail with concealed fixings Ø 32mm - UltraSatin	
UltraSatin polished satin stainless steel - L. 650mm	510160S
UltraSatin polished satin stainless steel - L. 850mm	510164S

Wall support rail

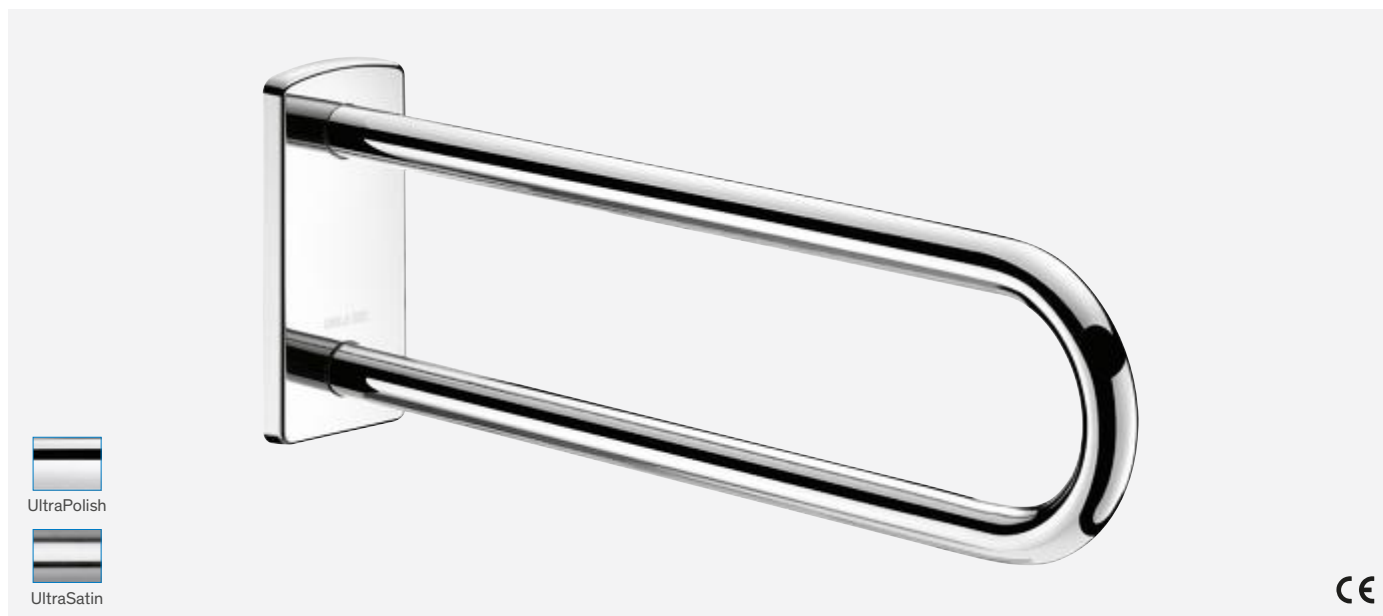

- For WCs, showers or washbasins.
- For use as a grab bar and a fixed support rail.
- Generally installed parallel to a drop-down support rail in a WC or on either side of a washbasin.
- Recommended if the WC pan or shower seat is a long way from the side wall.
- Dimensions: 650 × 230 × 105mm, Ø 32mm.
- Bacteriostatic 304 stainless steel tube.
- Stainless steel with UltraPolish bright polished finish or UltraSatin polished satin finish, uniform non-porous surface for easy maintenance and hygiene.
- Fixings, secured to wall by a 4mm thick 304 stainless steel plate, concealed by cover plate.
- Supplied with stainless steel screws for concrete walls.
- Tested to over 200kg. Maximum recommended user weight: 135kg.
- 10-year warranty.
- CE marked.

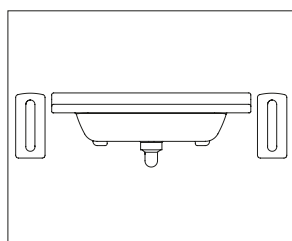

Installation example either side of a washbasin

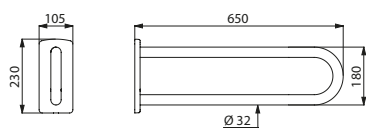

510161

Additional products



Backrest for WCs and toilet roll holder (see page 112)

Wall support rail Ø 32mm - L. 650mm	
UltraPolish bright polished stainless steel	510161P
UltraSatin polished satin stainless steel	510161S

Drop-down support rail with concealed fixings

With leg



Additional products



Backrest for WCs and toilet roll holder (see page 112)

- For WCs or showers.
- Allows side access in the raised position.
- In the lowered position use as a grab bar, as a support for standing and for assisting movement.
- With automatic folding leg. To be used as reinforcement when the wall fixing alone is insufficient.
- Leg height can be adjusted from 760 - 780mm.
- Dimensions: 850 or 650 × 800 × 105mm, Ø 32mm.
- Retained in upright position.
- Slowed down descent.
- Bacteriostatic 304 stainless steel tube.
- Stainless steel with UltraPolish bright polished finish or UltraSatin polished satin finish, uniform non-porous surface for easy maintenance and hygiene.
- Fixings, secured to wall by a 4mm thick 304 stainless steel plate, concealed by cover plate.
- Supplied with stainless steel screws for concrete walls.
- Tested to over 250kg.
- **Maximum recommended user weight: 170kg.**
- 10-year warranty.
- CE marked.

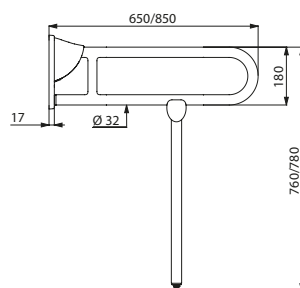
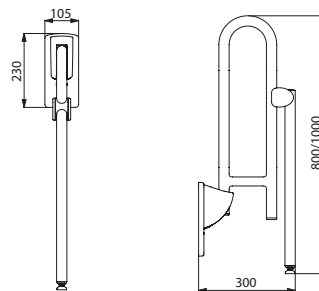

510162/510170

Related product

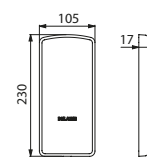

510150

Cover plate

- Conceals the fixing screws when the drop-down support rail is removed.
- Reduces the number of rails in a facility, allowing installation only when required e.g. hotels or hospitals accommodating a disabled person temporarily.
- Supplied with stainless steel screws for concrete walls.

Drop-down support rail with concealed fixings Ø 32mm with leg - UltraPolish	
UltraPolish bright polished stainless steel - L. 650mm	510162P
UltraPolish bright polished stainless steel - L. 850mm	510170P
Drop-down support rail with concealed fixings Ø 32mm with leg - UltraSatin	
UltraSatin polished satin stainless steel - L. 650mm	510162S
UltraSatin polished satin stainless steel - L. 850mm	510170S

Chrome-plated cover with fixing plate	510150
---------------------------------------	--------

Drop-down support rail

With leg



Additional products



Backrest for WCs
and toilet roll holder
(see page 112)

- For WCs or showers.
- Allows side access in the raised position.
- In the lowered position use as a grab bar, as a support for standing and for assisting movement.
- With automatic folding leg. To be used as reinforcement when the wall fixing alone is insufficient.
- Dimensions: 850 or 650 × 780 × 110mm, Ø 33.7mm.
- Bacteriostatic 304 stainless steel tube.
- Stainless steel with UltraPolish bright polished finish, uniform non-porous surface for easy maintenance and hygiene.
- Visible fixings secured to wall by a 304 stainless steel wall plate, 2.5mm thick.
- Supplied with stainless steel screws for concrete walls.
- Tested to over 200kg. Maximum recommended user weight: 135kg.
- 10-year warranty.
- CE marked.

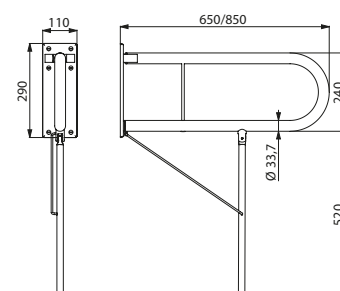

Drop-down support rail Ø 33.7mm with leg - UltraPolish	
UltraPolish bright polished stainless steel - L. 650mm	5162P1
UltraPolish bright polished stainless steel - L. 850mm	5170P1

5162P1/5170P1

Drop-down support rail

Without leg



- For WCs or showers.
- Allows side access in the raised position.
- In the lowered position use as a grab bar, as a support for standing and for assisting movement.
- Dimensions: 850 or 650 × 290 × 110mm, Ø 33.7mm.
- Bacteriostatic 304 stainless steel tube.
- Stainless steel with UltraPolish bright polished finish, uniform non-porous surface for easy maintenance and hygiene.
- Visible fixings secured to wall by a 304 stainless steel wall plate, 2.5mm thick.
- Supplied with stainless steel screws for concrete walls.
- Tested to over 200kg. Maximum recommended user weight: 135kg.
- 10-year warranty.
- CE marked.

Additional products



Backrest for WCs and toilet roll holder (see page 112)

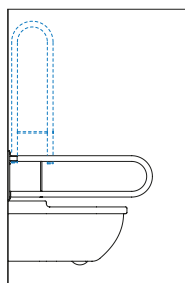

Installation example for WCs

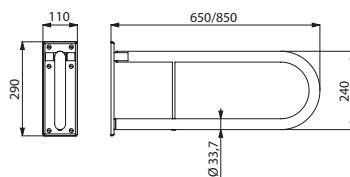

5160P1/5164P1

Drop-down support rail Ø 33.7mm - UltraPolish	
UltraPolish bright polished stainless steel - L. 650mm	5160P1
UltraPolish bright polished stainless steel - L. 850mm	5164P1

Hinged drop-down support rail

Without leg



UltraPolish

- For WCs or showers.
- Allows side access in the raised position.
- In the lowered position use as a grab bar, as a support for standing and for assisting movement.
- Can be stowed against wall to save space simply by rotating in the raised position.
- Dimensions : 650 × 290 × 110mm, Ø 33.7mm.
- Bacteriostatic 304 stainless steel tube.
- Stainless steel with UltraPolish bright polished finish, uniform non-porous surface for easy maintenance and hygiene.
- Visible fixings secured to wall by a 304 stainless steel wall plate, 2.5mm thick.
- Supplied with stainless steel screws for concrete walls.
- Tested to over 200kg. Maximum recommended user weight: 135kg.
- 10-year warranty.
- CE marked.

Additional products



Backrest for WCs and toilet roll holder (see page 112)

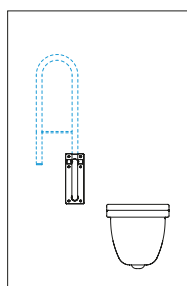

Installation example for WCs

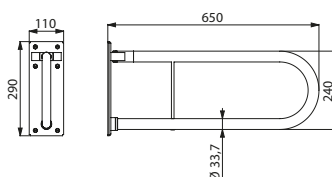

5163P1

Hinged drop-down support rail Ø 33.7mm
UltraPolish bright polished stainless steel L. 650mm

5163P1

Column for drop-down support rails



- For WCs or showers.
- Fixed to the floor by a 4-hole stainless steel plate, 5mm thick.
- For fixing a drop-down support rail when wall-mounting is not possible.
- Order with a drop-down support rail (only suitable for models on pages 96-98).
- Dimensions: 1,000 × 200 × 100mm.
- 2 or 3 stirrups, height can be adjusted.
- Square tube, 60 × 60mm.
- Stainless steel with polished satin finish.
- Tested to over 200kg.
- 10-year warranty.

Additional products



Drop-down support rails with or without leg
(see pages 96-98)

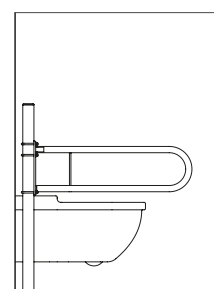

Installation example
for WCs

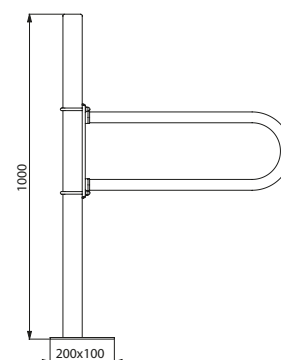

5169P1

Straight bar with sliding shower head holder

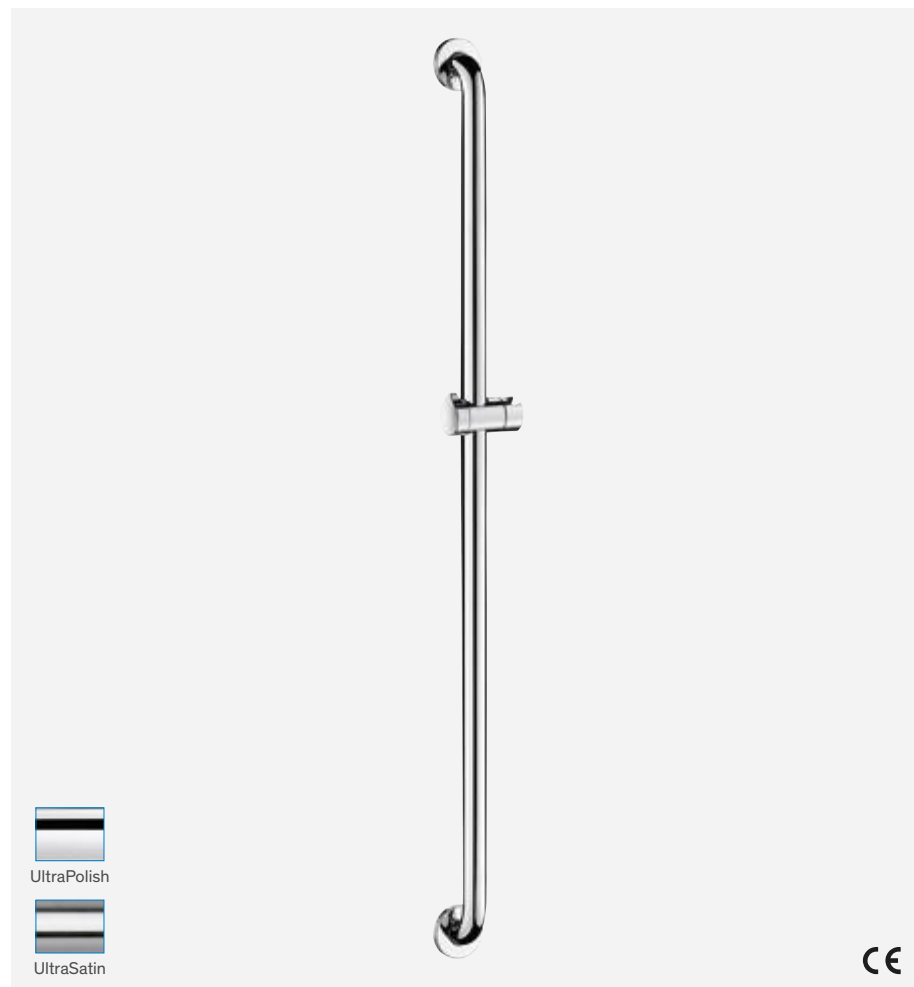

Additional products



Sliding soap dish and shower head
(see page 111)

- For showers or baths.
- Can be used as a vertical grab bar and a shower head rail.
- Chrome-plated sliding shower head holder with ergonomic locking ring.
- Sliding soap dish can be added (order separately).
- Height: 1,150mm, Ø 32mm.
- Bacteriostatic 304 stainless steel tube.
- Stainless steel with UltraPolish bright polished finish or UltraSatin polished satin finish, uniform non-porous surface for easy maintenance and hygiene.
- Plate welded to the tube by invisible safety bead weld (process exclusive to "ArN-Securit").
- 40mm gap between the bar and the wall: minimal space prevents the forearm passing between the bar and the wall, reducing the risk of fracture in case of loss of balance.
- Concealed fixings secured to wall by a 3-hole fixing plate, Ø 72mm. Fixing plates and cover plates in 304 stainless steel.
- Supplied with stainless steel screws for concrete walls.
- Tested to over 200kg. Maximum recommended user weight: 135kg.
- 10-year warranty.
- CE marked.

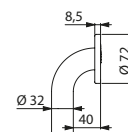

5460

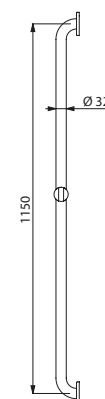

5460

Straight bar Ø 32mm with sliding shower head holder	
UltraPolish bright polished stainless steel	5460P2
UltraSatin polished satin stainless steel	5460S

Right angled shower grab bar



- For showers.
- Use as a grab bar and to support the user in an upright position.
- Helps and secures entry and movement in the shower.
- Use as a shower rail by adding a sliding shower head holder and/or soap dish.
- Dimensions: 1,265 × 560 × 660mm, Ø 32mm.
- Bacteriostatic 304 stainless steel tube.
- Stainless steel with UltraPolish bright polished finish or UltraSatin polished satin finish, uniform non-porous surface for easy maintenance and hygiene.
- Plate welded to the tube by invisible safety bead weld (process exclusive to "ArN-Securit").
- 40mm gap between the bar and the wall: minimal space prevents the forearm passing between the bar and the wall, reducing the risk of fracture in case of loss of balance.
- Concealed fixings secured to wall by a 3-hole fixing plate, Ø 72mm. Fixing plates and cover plates in 304 stainless steel.
- Supplied with stainless steel screws for concrete walls.
- Tested to over 200kg. Maximum recommended user weight: 135kg.
- 10-year warranty.
- CE marked.

Additional products

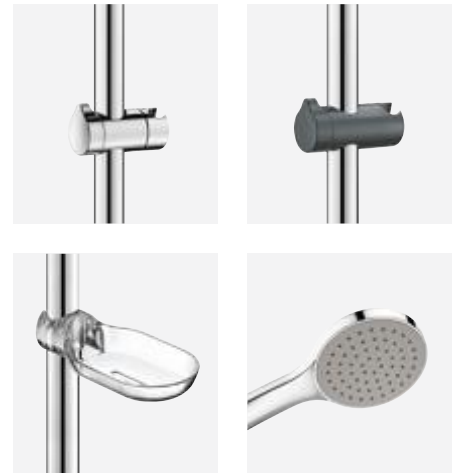

Sliding shower head holders, sliding soap dish and shower head (see page 111)

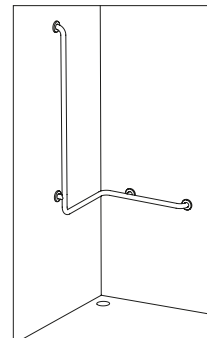

Installation example for showers

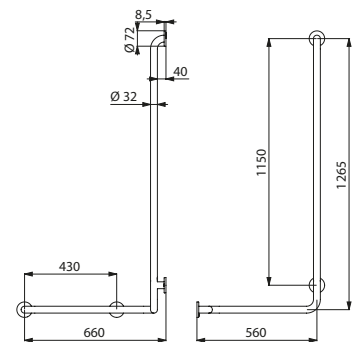

Left model - 5100G

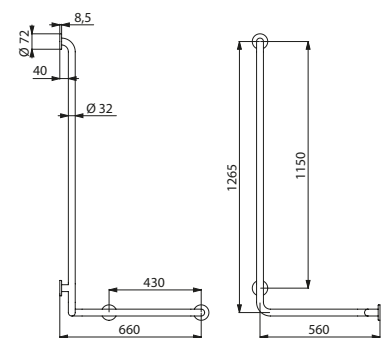

Right model - 5100D

Right angled shower grab bar Ø 32mm - UltraPolish	
UltraPolish bright polished stainless steel - Left model	5100GP2
UltraPolish bright polished stainless steel - Right model	5100DP2
Right angled shower grab bar Ø 32mm - UltraSatin	
UltraSatin polished satin stainless steel - Left model	5100GS
UltraSatin polished satin stainless steel - Right model	5100DS

ACCESSIBILITY
STAINLESS STEEL



L-shaped grab bar



Additional products

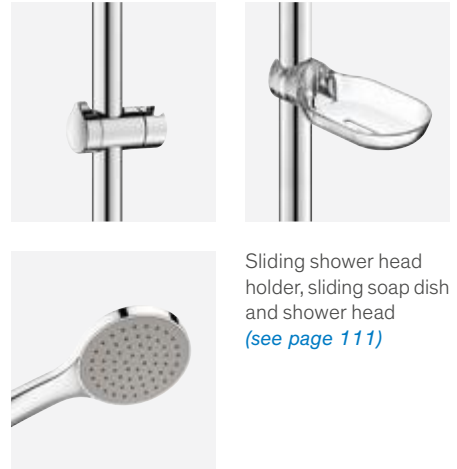

Sliding shower head holder, sliding soap dish and shower head (see page 111)

- For showers or baths.
- Helps the user stand and move safely in the shower or bath.
- Use as a shower rail by adding a sliding shower head holder and/or soap dish.
- Dimensions: 1,150 or 750 × 450mm, Ø 32mm.
- Bacteriostatic 304 stainless steel tube.
- Stainless steel with UltraPolish bright polished finish or UltraSatin polished satin finish, uniform non-porous surface for easy maintenance and hygiene.
- Plate welded to the tube by invisible safety bead weld (process exclusive to "ArN-Securit").
- 40mm gap between the bar and the wall: minimal space prevents forearm passing between the bar and the wall, reducing the risk of fracture in case of loss of balance.
- Concealed fixings secured to wall by a 3-hole fixing plate, Ø 72mm. Fixing plates and cover plates in 304 stainless steel.
- Supplied with stainless steel screws for concrete walls.
- Tested to over 200kg. Maximum recommended user weight: 135kg.
- 10-year warranty.
- CE marked.

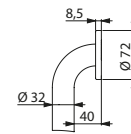

5070/5071

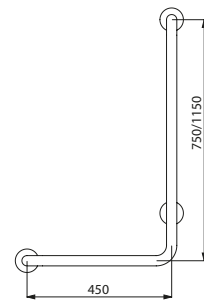

Left model
5070G/5071G

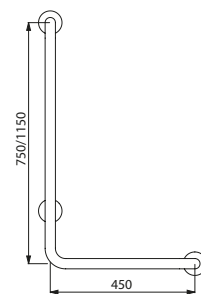

Right model
5070D/5071D

L-shaped grab bar Ø 32mm - Height 750mm	
UltraPolish bright polished stainless steel - Left model	5070GP2
UltraPolish bright polished stainless steel - Right model	5070DP2
UltraSatin polished satin stainless steel - Left model	5070GS
UltraSatin polished satin stainless steel - Right model	5070DS
L-shaped grab bar Ø 32mm - Height 1,150mm	
UltraPolish bright polished stainless steel - Left model	5071GP2
UltraPolish bright polished stainless steel - Right model	5071DP2
UltraSatin polished satin stainless steel - Left model	5071GS
UltraSatin polished satin stainless steel - Right model	5071DS

ACCESSIBILITY
STAINLESS STEEL

T-shaped grab bar



Additional products

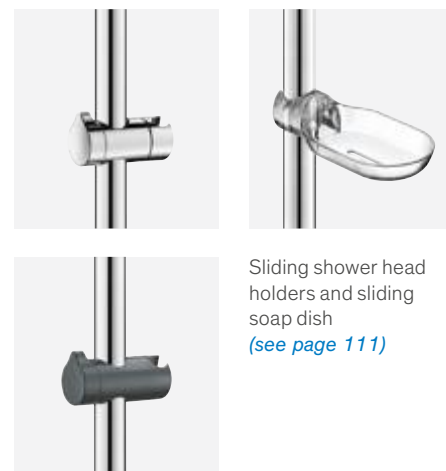

- For showers.
- Use as a grab bar and to support the user in an upright position.
- Helps and secures entry and movement in the shower.
- Use as a shower rail by adding a sliding shower head holder and/or soap dish.
- Dimensions: 1,150 × 500mm, Ø 32mm.
- Bacteriostatic 304 stainless steel tube.
- Stainless steel with UltraPolish bright polished finish or UltraSatin polished satin finish, uniform non-porous surface for easy maintenance and hygiene.
- Plate welded to the tube by invisible safety bead weld (process exclusive to "ArN-Securit").
- 40mm gap between the bar and the wall: minimal space prevents the forearm passing between the bar and the wall, reducing the risk of fracture in case of loss of balance.
- Concealed fixings secured to wall by a 3-hole fixing plate, Ø 72mm. Fixing plates and cover plates in 304 stainless steel.
- Supplied with stainless steel screws for concrete walls.
- Tested to over 200kg. Maximum recommended user weight: 135kg.
- 10-year warranty.
- CE marked.

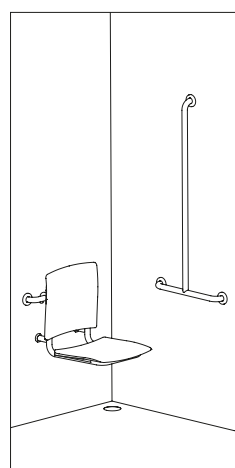

Installation example for showers

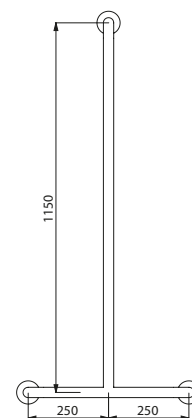
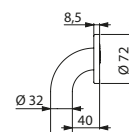

5440

T-shaped grab bar Ø 32mm	
UltraPolish bright polished stainless steel	5440P2
UltraSatin polished satin stainless steel	5440S

T-shaped grab bar with sliding vertical bar



Additional products

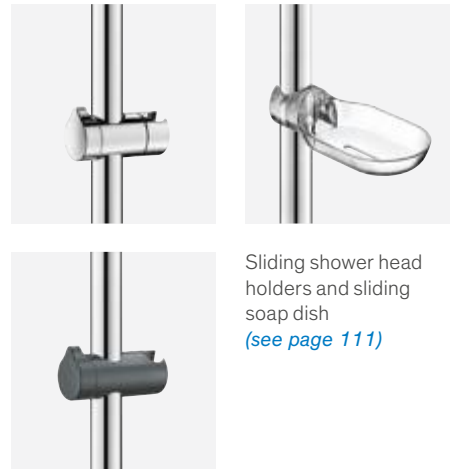

Sliding shower head holders and sliding soap dish (see page 111)

ACCESSIBILITY
STAINLESS STEEL

- For showers.
- Use as a grab bar and to support the user in an upright position.
- Helps and secures entry and movement in the shower.
- Use as a shower rail by adding a sliding shower head holder and/or soap dish.
- Upright position can be adjusted during installation: can be moved to the left or the right in order to adapt the space (positioning of shower, depth of shower seat...).
- Dimensions: 1,160 × 500mm, Ø 32mm.
- Bacteriostatic 304 stainless steel tube.
- Stainless steel with UltraPolish bright polished finish or UltraSatin polished satin finish, uniform non-porous surface for easy maintenance and hygiene.
- Plate welded to the tube by invisible safety bead weld (process exclusive to "ArN-Securit").
- 40mm gap between the bar and the wall: minimal space prevents the forearm passing between the bar and the wall, reducing the risk of fracture in case of loss of balance.
- Concealed fixings secured to wall by a 3-hole fixing plate, Ø 72mm. Fixing plates and cover plates in 304 stainless steel.
- Supplied with stainless steel screws for concrete walls.
- Tested to over 200kg. Maximum recommended user weight: 135kg.
- 10-year warranty.
- CE marked.

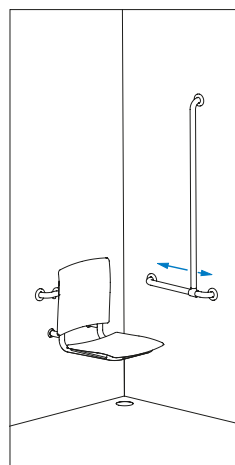

Upright can be moved

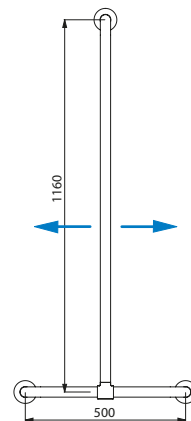
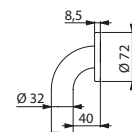

5441

Provisional availability 1st half 2019. Please contact sales office to check availability.

T-shaped grab bar with sliding vertical bar Ø 32mm	
UltraPolish bright polished stainless steel	5441P
UltraSatin polished satin stainless steel	5441S

Two-wall corner grab bar with vertical bar

For shower seats



Additional products



Removable shower seat (see page 81), sliding shower head holders and sliding soap dish (see page 111)

- For showers.
- Can support a removable shower seat (order separately).
- Use as a grab bar and to support the user in an upright position.
- Helps and secures entry and movement in the shower.
- Use as a shower rail by adding a sliding shower head holder and/or soap dish.
- Dimensions: 1,150 × 750 × 750mm, Ø 32mm.
- Bacteriostatic 304 stainless steel tube.
- Stainless steel with UltraPolish bright polished finish or UltraSatin polished satin finish, uniform non-porous surface for easy maintenance and hygiene.
- Plate welded to the tube by invisible safety bead weld (process exclusive to "ArN-Securit").
- 40mm gap between the bar and the wall: minimal space prevents the forearm passing between the bar and the wall, reducing the risk of fracture in case of loss of balance.
- Concealed fixings secured to wall by a 3-hole fixing plate, Ø 72mm. Fixing plates and cover plates in 304 stainless steel.
- Supplied with stainless steel screws for concrete walls.
- Tested to over 200kg. Maximum recommended user weight: 135kg.
- 10-year warranty.
- CE marked.

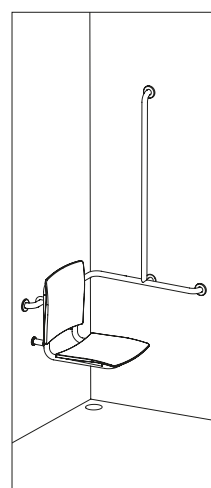

Installation example for showers

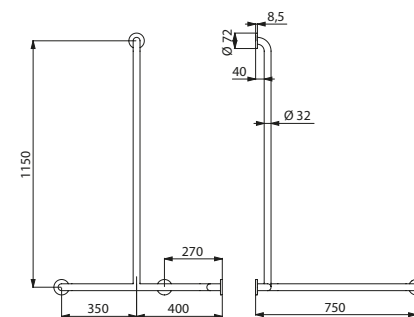

Left model - 5481G

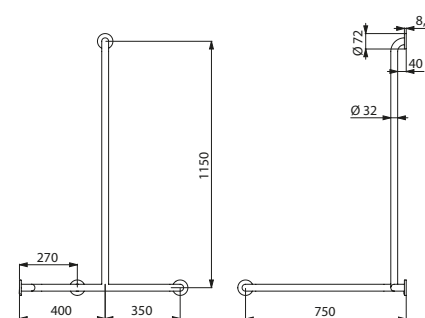

Right model - 5481D

Two-wall corner grab bar with vertical bar Ø 32mm for shower seats - UltraPolish	
UltraPolish bright polished stainless steel - Left model	5481GP2
UltraPolish bright polished stainless steel - Right model	5481DP2
Two-wall corner grab bar with vertical bar Ø 32mm for shower seats - UltraSatin	
UltraSatin polished satin stainless steel - Left model	5481GS
UltraSatin polished satin stainless steel - Right model	5481DS

Two-wall grab bar with sliding vertical bar

For shower seats



Additional products



Removable shower seat (see page 81), sliding shower head holders and sliding soap dish (see page 111)

- For showers.
- Can support a removable shower seat (order separately).
- Use as a grab bar and to support the user in an upright position.
- Helps and secures entry and movement in the shower.
- Use as a shower rail by adding a sliding shower head holder and/or soap dish.
- Upright position can be adjusted during installation: can be moved to the left or the right in order to adapt the space (positioning of shower, depth of shower seat...).
- Can be installed with the upright on the left or the right.
- Dimensions: 1,160 × 750 × 750mm, Ø 32mm.
- Bacteriostatic 304 stainless steel tube.
- Stainless steel with UltraPolish bright polished finish or UltraSatin polished satin finish, uniform non-porous surface for easy maintenance and hygiene.
- Plate welded to the tube by invisible safety bead weld (process exclusive to "ArN-Securit").
- 40mm gap between the bar and the wall: minimal space prevents the forearm passing between the bar and the wall, reducing the risk of fracture in case of loss of balance.
- Concealed fixings secured to wall by a 3-hole fixing plate, Ø 72mm. Fixing plates and cover plates in 304 stainless steel.
- Supplied with stainless steel screws for concrete walls.
- Tested to over 200kg. Maximum recommended user weight: 135kg.
- 10-year warranty.
- CE marked.

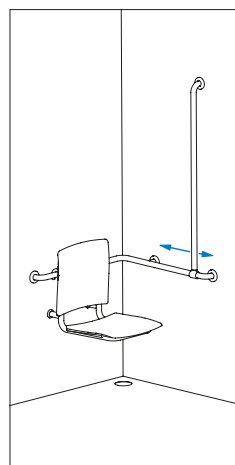

Upright can be moved to the left or the right.

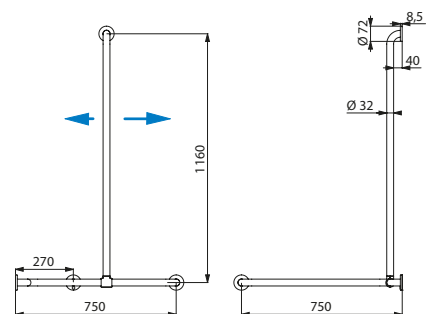
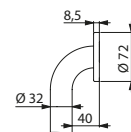

5481

Provisional availability 1st half 2019. Please contact sales office to check availability.

Two-wall grab bar with sliding vertical bar Ø 32mm for shower seats	
UltraPolish bright polished stainless steel	5481P
UltraSatin polished satin stainless steel	5481S

ACCESSIBILITY
STAINLESS STEEL

Two-wall corner grab bar

For shower seats



- For WCs, showers or baths.
- Can support a removable shower seat (order separately).
- Use as a grab bar and to support the user in an upright position.
- Helps and secures entry and movement in the shower or bath.
- Helps with the transfer from a wheelchair to the toilet seat for WCs with recessed cisterns or direct flush.
- Dimensions: 750 × 750mm, Ø 32mm.
- Bacteriostatic 304 stainless steel tube.
- Stainless steel with UltraPolish bright polished finish or UltraSatin polished satin finish, uniform non-porous surface for easy maintenance and hygiene.
- Plate welded to the tube by invisible safety bead weld (process exclusive to "ArN-Securit").
- 40mm gap between the bar and the wall:
 - minimal space prevents the forearm passing between the bar and the wall, reducing the risk of fracture in case of loss of balance.
- Concealed fixings secured to wall by a 3-hole fixing plate, Ø 72mm. Fixing plates and cover plates in 304 stainless steel.
- Supplied with stainless steel screws for concrete walls.
- Tested to over 200kg. Maximum recommended user weight: 135kg.
- 10-year warranty.
- CE marked.

Additional product



Removable shower seat (see page 81)

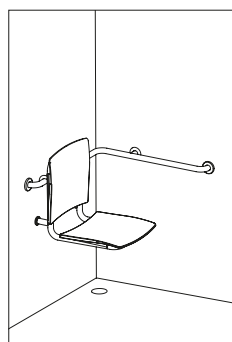

Installation example for showers

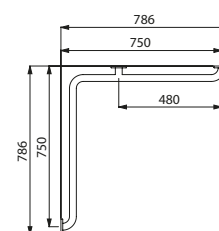
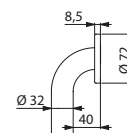

Two-wall corner grab bar Ø 32mm for shower seats	
UltraPolish bright polished stainless steel	5120P2
UltraSatin polished satin stainless steel	5120S

5120

Single grab bar

For shower seats



- For showers.
- Can support a removable shower seat (order separately).
- Can be used as a grab bar and to support the user in an upright position.
- Helps and secures entry and movement in the shower.
- Dimensions: 500mm, Ø 32mm.
- Bacteriostatic 304 stainless steel tube.
- Stainless steel with UltraPolish bright polished finish or UltraSatin polished satin finish, uniform non-porous surface for easy maintenance and hygiene.
- Plate welded to the tube by invisible safety bead weld (process exclusive to "ArN-Securit").
- 40mm gap between the bar and the wall: minimal space prevents the forearm passing between the bar and the wall, reducing the risk of fracture in case of loss of balance.
- Concealed fixings secured to wall by a 3-hole fixing plate, Ø 72mm. Fixing plates and cover plates in 304 stainless steel.
- Supplied with stainless steel screws for concrete walls.
- Tested to over 200kg. Maximum recommended user weight: 135kg.
- 10-year warranty.
- CE marked.

Additional product



Removable shower seat (see page 81)

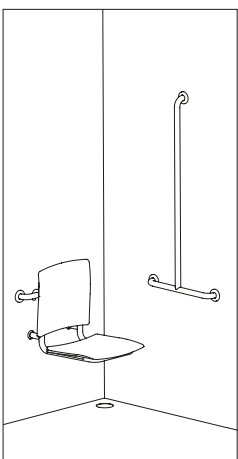

Installation example for showers

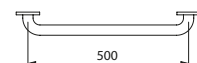
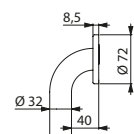

5050S

Grab bar Ø 32mm for shower seats	
UltraPolish bright polished stainless steel	50505P2
UltraSatin polished satin stainless steel	50505S

Lift-up shower curtain rail



UltraPolish bright polished 304 stainless steel

- **Allows side access in the raised position.**
- **Preserves the patient's privacy in the lowered position.**
- **Allows a carer to assist with bathing a patient while protecting them from splashes.**
- Dimensions: 900 × 230 × 105mm, Ø 32mm.
- **Retained in upright position.**
- **Slowed down descent.**
- Bacteriostatic 304 stainless steel tube.
- Fixings, secured to wall by a 4mm thick 304 stainless steel plate, concealed by cover plate.
- Supplied with stainless steel screws for concrete walls.
- 10-year warranty.

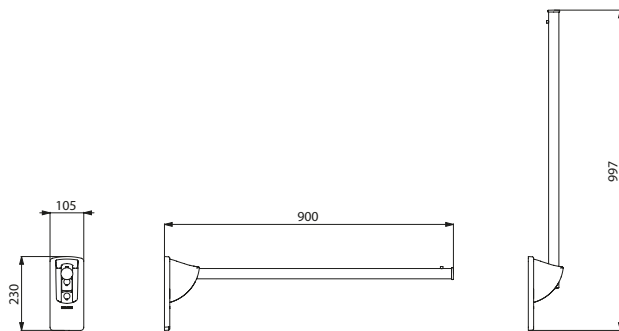

510159

Lift-up shower curtain rail	
UltraPolish bright polished 304 stainless steel	510159P
UltraSatin polished satin 304 stainless steel	510159S



UltraSatin polished satin 304 stainless steel

Related product

Shower curtain



- Material: polyester.
- **Bottom of curtain is weighted.**
- Dimensions: L. 880 × H. 790mm.
- Supplied with 6 plastic curtain rings.

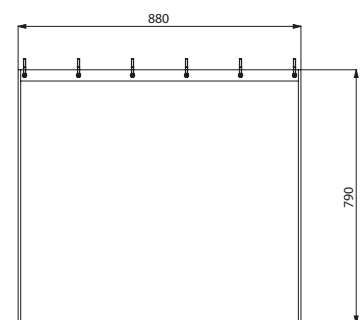

510158

Shower curtain with 6 curtain rings	510158
--	---------------

Nylon sliding shower head holder



- High-strength polyamide (Nylon).
- Support for adjustable shower heads.
- Ergonomic locking ring.
- For \varnothing 32mm grab bars (see refs. 5100, 5440, 5441 and 5481 pages 101 to 107).

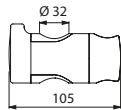

510110NG

Sliding shower head holder Nylon HR bright anthracite grey	510110NG
---	----------

Clip-on sliding soap dish



- Soap dish for shower gel or soap.
- For \varnothing 25 and \varnothing 32mm grab bars.

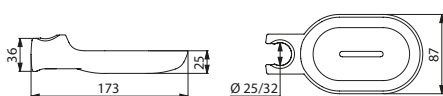

510120

Clip-on soap dish	
Translucent	510120
HR Nylon bright white	510120N

Chrome-plated sliding shower head holder



- Fixes separately onto the bar and can be added after installation.
- Support for adjustable shower heads.
- Ergonomic locking ring.
- For \varnothing 25 and \varnothing 32mm grab bars.

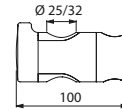

4110P

Chrome-plated sliding shower head holder	4110P
--	-------

Shower head



- M1/2" shower head in chrome-plated ABS.
- Monojet: rain effect.
- Manual system for removing limescale.

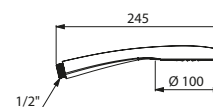

815

Rain effect shower head	815
-------------------------	-----

ACCESSIBILITY
STAINLESS STEEL

Toilet roll holder for grab bars



- High-strength polyamide (Nylon).
- Can be fitted without removing grab bar.
- Locks in place to prevent theft.
- Anti-rotating locking feature.
- **For Ø 32 - 34mm grab bars.**

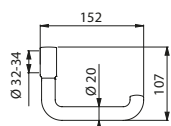

510081

Toilet roll holder for grab bars	
HR Nylon bright anthracite grey	510081
HR Nylon bright white	510081N

Comfort backrest for WCs



- Backrest made from soft polyurethane.
- Bacteriostatic 304 stainless steel tube, Ø 25 × 1.2mm.
- Concealed fixings secured to wall by a 3-hole fixing plate, Ø 72mm. Fixing plates and cover plates in 304 stainless steel.
- Dimensions: 150 × 580 × 173mm.
- CE marked.

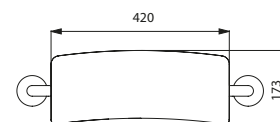
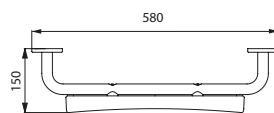

510629

Comfort backrest for WCs	
UltraPolish bright polished 304 stainless steel structure	510629
UltraSatin polished satin 304 stainless steel structure	510629S

Solid cover plate



- Bacteriostatic 304 stainless steel.
- For thin walls or doors: hides cross wall fixings.
- Ø 72mm.

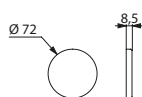

CPP32

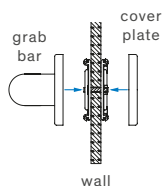

Solid cover plate	
UltraPolish bright polished 304 stainless steel	CPP32P
UltraSatin satin polished 304 stainless steel	CPP32S

Toilet booster seat with lid



- White plastic with side fixing.
- Width can be adjusted from 320 - 380mm.
- Supports weights up to 225kg.
- CE marked.

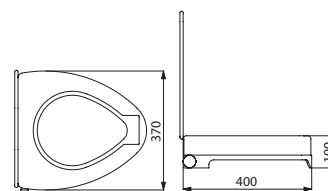

435

Toilet booster seat with lid	
	435

Coat hook



- Bacteriostatic 304 stainless steel.
- Tube Ø 20mm, 1mm thick.
- Short model: L. 65mm.
- Long model: L. 100mm
- Concealed fixings.

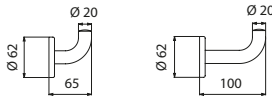

4043

4047

Coat hook - Short model	
Bright polished 304 stainless steel	4043P
Polished satin 304 stainless steel	4043S
White p. coated 304 stainless steel	4043EW
Coat hook - Long model	
Bright polished 304 stainless steel	4047P
White p. coated 304 stainless steel	4047EW

Double coat hook



- Bacteriostatic 304 stainless steel.
- Tube Ø 20mm, 1mm thick.
- Concealed fixings.

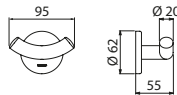

4042

Double coat hook	
Bright polished 304 stainless steel	4042P
Polished satin 304 stainless steel	4042S
White powder-coated 304 stainless steel	4042W

U-shaped toilet roll holder



- Bacteriostatic 304 stainless steel.
- Tube Ø 20mm, 1mm thick.
- Concealed fixings.

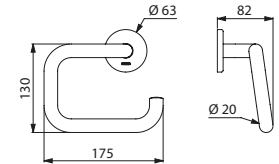

4081

U-shaped toilet roll holder	
Bright polished 304 stainless steel	4081P
Polished satin 304 stainless steel	4081S
White powder-coated 304 stainless steel	4081EW

Spare toilet roll holder

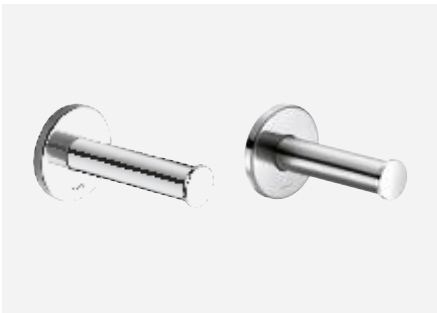

- Bacteriostatic 304 stainless steel.
- Tube Ø 25mm, 1.2mm thick.
- Concealed fixings.

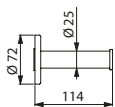

4070

Spare toilet roll holder	
Bright polished 304 stainless steel	4070P
Polished satin 304 stainless steel	4070S

Toilet roll holder or for spares



- Bacteriostatic 304 stainless steel.
- Can be installed horizontally for main use, or vertically as a spare toilet roll holder.
- Tube Ø 20mm, 1mm thick.
- Concealed fixings.

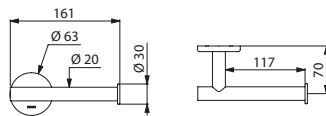

510083

Toilet roll holder or for spares	
Bright polished 304 stainless steel	510083P
Polished satin 304 stainless steel	510083S
White p. coated 304 stainless steel	510083W

Twin toilet roll holder



- Bacteriostatic 304 stainless steel.
- For two toilet rolls.
- Tube Ø 20mm, 1mm thick.
- Concealed fixings.

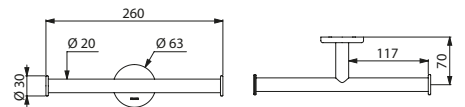

510082

Twin toilet roll holder	
Bright polished 304 stainless steel	510082P
Polished satin 304 stainless steel	510082S
White p. coated 304 stainless steel	510082W

ACCESSIBILITY
STAINLESS STEEL

Toilet brush set without lid



- **Robust model.**
- **Bacteriostatic 304 stainless steel.**
- Wall-mounted or floor-standing.
- Easy to clean: plastic bowl can be removed from above.
- **Plastic bowl with reservoir:** prevents toilet brush sitting in residual water and reduces the risk of splashing when next used.
- **Anti-theft lock** (wall-mounted model).
- Stainless steel thickness: 1mm body.
- Dimensions: Ø 90 × 330mm.

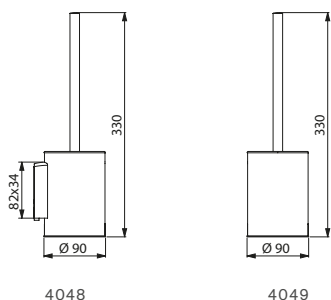

Wall-mounted toilet brush set without lid - Anti-theft lock	
Bright polished 304 stainless steel	4048P
Polished satin 304 stainless steel	4048S
White powder-coated 304 stainless steel	4048EW
Floor-standing toilet brush set without lid	
Bright polished 304 stainless steel	4049P
Polished satin 304 stainless steel	4049S
White powder-coated 304 stainless steel	4049EW

Toilet brush set with lid



- **Robust model.**
- **Bacteriostatic 304 stainless steel.**
- Wall-mounted or floor-standing.
- Model with **long ergonomic handle:** easy to use for wheelchair users or those with difficulty bending.
- Easy to clean: plastic bowl can be removed from above.
- **Plastic bowl with reservoir:** prevents toilet brush sitting in residual water and reduces the risk of splashing when next used.
- Toilet brush **automatically centres itself** in the holder.
- **Anti-theft lock** (wall-mounted model).
- Stainless steel thickness: 1mm body.
- Dimensions: Ø 90 × 410mm or 580mm.

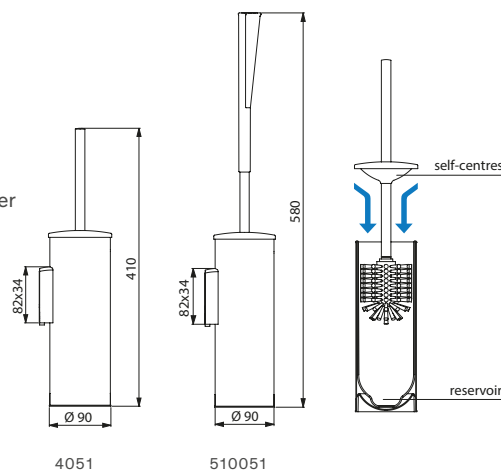

Wall-mounted toilet brush set with lid - Anti-theft lock	
Bright polished 304 stainless steel	4051P
Polished satin 304 stainless steel	4051S
White powder-coated 304 stainless steel	4051EW
Wall-mounted toilet brush set with lid and long handle - Anti-theft lock	
Bright polished 304 stainless steel	510051P
Polished satin 304 stainless steel	510051S
White powder-coated 304 stainless steel	510051W
Floor-standing toilet brush set with lid	
Bright polished 304 stainless steel	4050P
Polished satin 304 stainless steel	4050S
White powder-coated 304 stainless steel	4050EW
Floor-standing toilet brush set with lid and long handle	
Bright polished 304 stainless steel	510050P
Polished satin 304 stainless steel	510050S
White powder-coated 304 stainless steel	510050W

1-metre stainless steel mirror

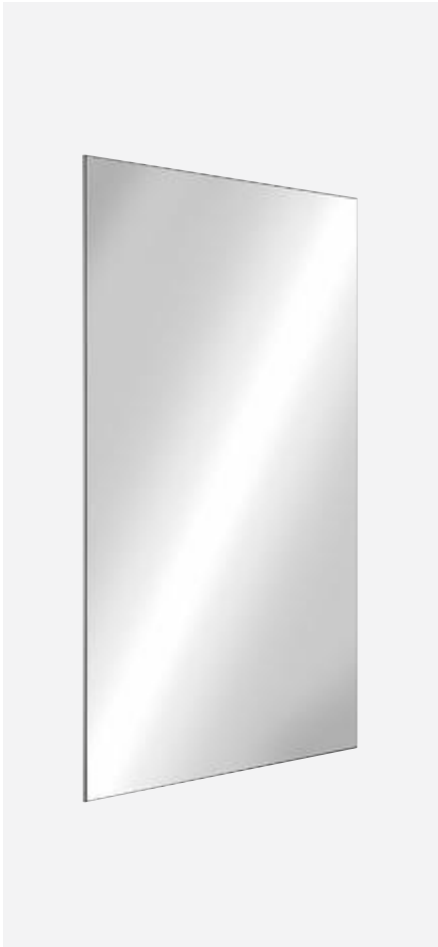

- **For combined installation:** height enables use from standing or sitting positions, or from a wheelchair.
- **"Mirror" polished** bacteriostatic 304 stainless steel.
- **Reinforced by a concealed solid PVC plate** 10mm thick.
- 5 fixing points. Concealed fixings.
- **Unbreakable.**
- Dimensions : 10 × 595 × 980 mm.

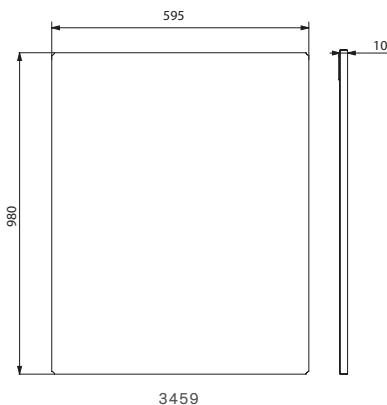

Stainless steel mirror	3459
For more mirrors and studded pegs see pages 41-43.	

Tilting mirror

Long, ergonomic lever



- **For combined installation:** can be used from sitting or standing position.
- **Long, ergonomic lever for easy adjustment of mirror angle from a sitting position or from a wheelchair.**
- **Quick and easy to install:** simply clip into place.
- **Anti-theft lock.**
- Bright white HR Nylon lever.
- Mirror made from 6mm Securit safety glass.
- Mirror dimensions: 500 × 600mm.
- Can be tilted up to 20°.

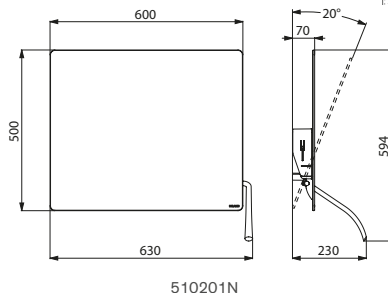

Tilting mirror with long, ergonomic lever	510201N
For more mirrors and studded pegs see pages 41-43.	

Tilting mirror

Tab handle



- **For combined installation:** can be used from sitting or standing position.
- **Tab handle for easy adjustment of mirror angle for those in a sitting position or for wheelchair users.**
- **Quick and easy to install:** simply clip into place.
- **Anti-theft lock.**
- Mirror made from 6mm Securit safety glass.
- Mirror dimensions: 500 × 600mm.
- Can be tilted up to 20°.

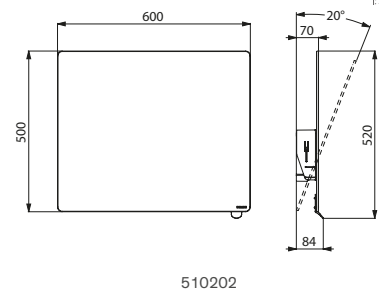

Tilting mirror with tab handle	
Chrome-plated bright tab	510202P
Chrome-plated satin tab	510202S
White Nylon tab	510202N
For more mirrors and studded pegs see pages 41-43.	

ACCESSIBILITY
STAINLESS STEEL

Wall-hung 700 S WC pan



- Wall-hung WC pan.
- 700mm **elongated pan** for improved comfort for people with reduced mobility.
- Compatible with all standard frame systems available on the market.
- Elegant and simple design.
- **Bacteriostatic 304 stainless steel.**
- Stainless steel thickness: 1.5mm.
- One-piece pressed WC bowl, seam-free for easy maintenance and better hygiene.
- WC bowl surface is polished with rounded edges for easy cleaning.
- Concealed perimetral flushing rim.
- Horizontal water inlet: Ø 55mm.
- Horizontal waste outlet: Ø 100mm.
- Water saving: works with 4L or more of water.
- Shrouded WC pan.
- Pre-drilled holes for fixing the toilet seat. Supplied with stainless steel blanking caps when installed without toilet seat lid.
- Quick and easy to install from the front thanks to a stainless steel mounting frame.
- Supplied with fixing plate and 6 theft prevention TORX security screws.
- Weight: 14.5kg.
- CE marked. Complies with European standard EN 997 for 4L flush.

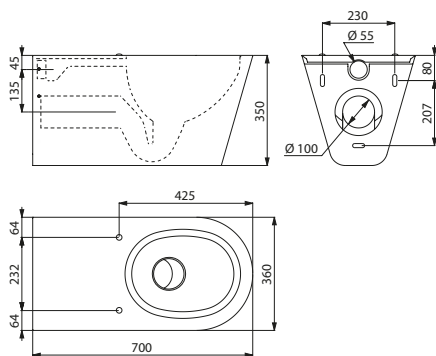

110710

Wall-hung 700 S WC - Polished satin 304 stainless steel 110710

MONOBLOCO 700 PMR WC



- Floor-standing WC pan with dual flush cistern 3L/6L.
- 700mm **elongated pan** for improved comfort for people with reduced mobility.
- **Bacteriostatic 304 stainless steel.**
- Stainless steel thickness: 1.5mm.
- One-piece pressed WC bowl, seam-free for easy maintenance and better hygiene.
- WC bowl surface is polished with rounded edges for easy cleaning.
- Concealed perimetral flushing rim. Water supply can be recessed from below or exposed from the side (right/left).
- Recessed horizontal or vertical waste outlet. Supplied with PVC pipe.
- Pre-drilled holes for fixing the toilet seat. Supplied with stainless steel blanking caps when installed without toilet seat lid.
- Quick to install: 2 access panels with theft prevention TORX security screws.
- Weight: 22kg.
- CE marked. Complies with European standard EN 997 for 4L flush.

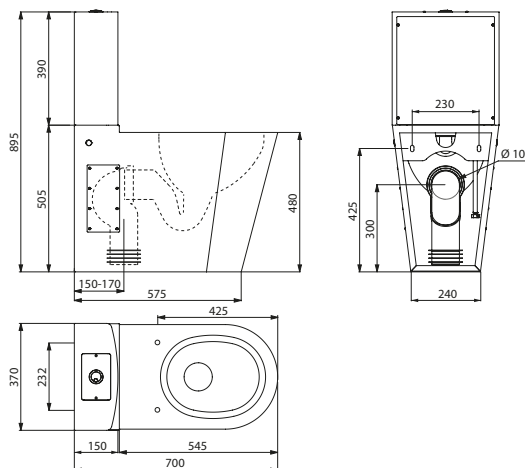

110790

Monobloco 700 PMR WC - Polished satin 304 stainless steel 110790

PMR XS hand washbasin



CE

- Wall-mounted hand washbasin **suitable for people with reduced mobility.**
- Basin internal diameter: 310mm.
- **Bacteriostatic 304 stainless steel.**
- Stainless steel thickness: 1.2mm.
- Rounded edges prevent injury.
- Supplied with 1¼" waste.
- Without overflow.
- Supplied with fixing elements.
- Weight: 3.9kg.
- CE marked. Complies with European standard EN 14688.

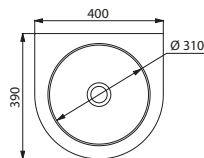
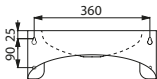
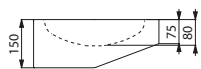

120400

PMR XS washbasin Polished satin 304 stainless steel	120400
---	---------------

TRAPEZ washbasin



CE

- Wall-mounted washbasin, 600 × 505mm.
- **Shallow basin suitable for people with reduced mobility.**
- **Bacteriostatic 304 stainless steel.**
- Stainless steel thickness: 1.2mm.
- Rounded edges prevent injury.
- Supplied with 1¼" waste.
- Without overflow.
- Supplied with fixing elements.
- Weight: 5.5kg.
- CE marked. Complies with European standard EN 14688.

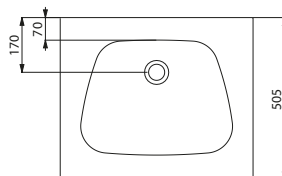
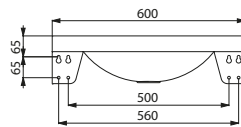
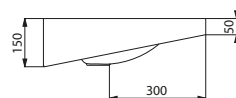

120270

Wall-mounted TRAPEZ washbasin Polished satin 304 stainless steel	
Without tap hole	120270
With central Ø 35mm tap hole	121270

PMR shower tray



CE

- Recessed shower tray.
- **Suitable for people with reduced mobility:** slimline shower tray.
- **Bacteriostatic 304 stainless steel.**
- Stainless steel thickness: 1.5mm.
- Depth: 30mm.
- Drainage slope.
- Supplied with 1½" waste.
- Non-slip surface.
- Weight of 800 × 800mm model: 8.5kg.
- Weight of 900 × 900mm model: 9.5kg.
- CE marked. Complies with European standard EN 14527.

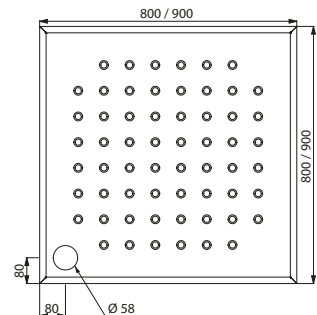
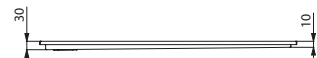

150500/150600

Recessed shower tray	
Polished satin 304 stainless steel 800 × 800mm	150500
Polished satin 304 stainless steel 900 × 900mm	150600

ACCESSIBILITY
STAINLESS STEEL



U-shaped toilet roll holder **4081N** - 135° grab bar **5081N** - TEMPOFIX 3 frame system with TEMPOMATIC direct flush electronic valve **564065DE-464006**
Nylon drop-down rail **5164N** - Wall-mounted toilet brush set with ergonomic handle **4051N**

Accessibility and Independence Nylon Range

SHOWER SEATS
123



GRAB BARS
126



DROP-DOWN SUPPORT RAILS
130

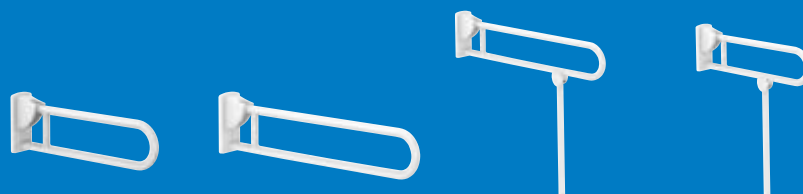

SHOWER GRAB BARS
132



ACCESSORIES
142

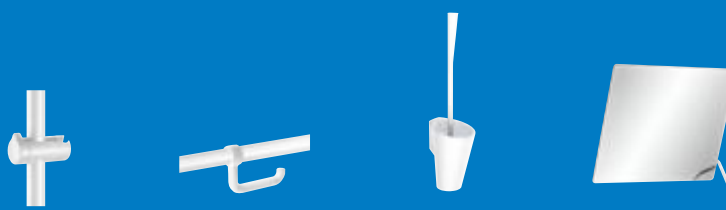



MAXIMUM SAFETY

Tested to over 200kg

In public and commercial places, the user weight is unknown. The products installed must therefore be able to support any user.

10-year warranty

DELABIE's grab bars and shower seats are suitable for intensive use in all types of public or healthcare buildings.

Colour is added to the Nylon during manufacture ensuring a consistent colour throughout the bar. An anti-UV treatment prevents products from yellowing or ageing prematurely when exposed to strong light. DELABIE's Nylon products remain in perfect condition throughout their lifespan.

CE marked

DELABIE's grab bars and shower seats are CE marked and conform to European Directive 93/42/CEE that relates to medical devices, and complies with European standard EN 12182 "Technical aids for disabled people". This provides an additional guarantee for product users.

Reinforced metal core

The 3.5mm Nylon casing is reinforced with a 2mm non-corrosive steel core. The core, along with the other elements, is made from highly resistant technical materials.

38mm safety gap

The elderly or people with reduced mobility can easily lose their balance and fall. Limiting the gap between the bar and the wall to just 38mm prevents the forearm from getting trapped and significantly reduces the risk of fracture.

Space saving

Since they are closer to the wall, the grab bars require less space. This improves access within the sanitary facilities (showers, WCs, etc.) providing greater freedom of movement.

The grab bars are also more discreet.

Concealed fixings

All fixings (wall plate with 6 possible fixing points) are concealed by a Nylon cover plate.

MAXIMUM HYGIENE AND ERGONOMY

Bright HR Nylon

The Nylon used in the manufacture of DELABIE's grab bars is very high quality. The surface is perfectly uniform and non-porous for easy cleaning, ensuring the highest standards of hygiene. Compared to other synthetic materials it is highly resistant to abrasions, cracks and heat.

Nylon's technical properties are ideal for use in environments where hygiene is of the utmost importance e.g. hospitals, retirement homes, schools etc.

“Uniform non-porous surface, ensures easy maintenance and hygiene.”

Resistant to chemicals

DELABIE's Nylon products will withstand the main cleaning products used in hospitals and commercial environments.

Seam-free straight sections

Particular attention has been paid to the design of DELABIE's Nylon grab bars to reduce the number of joins and seams. This reduces the build-up of dirt, niches where bacteria can develop and the appearance of a black line, especially on the straight sections which are extruded in one-piece, and which have the most frequent contact with hands.

Smooth and warm to the touch

Optimised grip

The 32mm diameter of the grab bars ensures an optimum grip regardless of the end-use of the products. For healthcare facilities or public buildings we recommend grab bars with a diameter of 32mm.

AND ALSO...

100% interchangeable

The fixing plates for the bars are indexed and the dimensions are checked during the manufacturing process. There is no need to drill additional holes in the wall if replacing the bar with an identical one.

100% recyclable

The bars are made from 100% recyclable materials, contributing to sustainable development and protecting the environment.

Complete range

Offering a wide range of products enables DELABIE to respond to the needs and requirements of the accessibility and independence sector. This offering complements DELABIE's other product ranges perfectly.

**TESTED TO OVER 200KG
10-YEAR WARRANTY
CE MARKED**

38MM SAFETY GAP
Reduced risk of fracture
Space saving

**3.5MM NYLON
CASING**

**2MM REINFORCED
METAL CORE**
High resistance

**FIXINGS CONCEALED
BY 1MM NYLON COVER
PLATES**

**FIXING PLATES
ARE INDEXED**
100% interchangeable

**BRIGHT HR
NYLON**
Easy to clean

**RESISTANT
TO CHEMICALS**

SEAM-FREE
No bacterial niches

**SMOOTH
AND WARM
TO TOUCH**

TUBE Ø 32MM
Optimised grip

100% RECYCLABLE



Removable shower seat

To hang on grab bars



Additional products

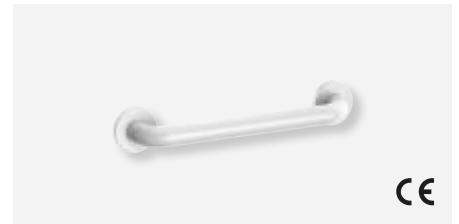

Grab bars for shower seats
(see pages 138-141)

- **HR Comfort shower seat and backrest.**
- **Large model.**
- To hang on grab bars Ø 32mm
(see refs. 5490N, 5481N, 5121N and 50504N pages 138-141).
- **Removable:** reduces the number of shower seats in a facility, allowing installation only when required e.g. hotels or hospitals providing short-term accommodation for people with reduced mobility.
- Dimensions: 590 × 420 × 510mm.
- Suitable for intensive use in public places or the healthcare sector.
- Detachable solid seat made from high-strength polymer.
- Uniform non-porous surface for easy maintenance and hygiene.
- Good resistance to chemical products and cleaning.
- Anti-UV treatment.
- Warm to the touch.
- Bacteriostatic 304 stainless steel structure Ø 32mm.
- **Adjustable screw jacks guarantee a good horizontal position.**
- **Large protective caps prevent damage to the wall.**
- Tested to over 200kg. Maximum recommended user weight: 135kg.
- 10-year warranty.
- CE marked.

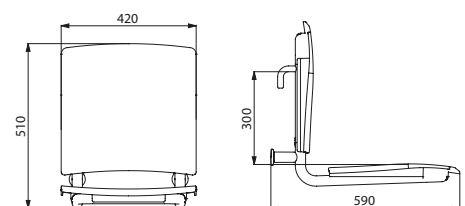

Removable Comfort shower seat to hang on grab bars
White powder-coated stainless steel structure

510300N

510300N

Lift-up shower seat



- **HR Comfort shower seat and backrest.**
- **Large model.**
- Dimensions: 506 × 420 × 620mm.
- Folded dimensions: 120 × 620mm.
- **Retained in upright position.**
- **Slowed down descent.**
- Suitable for intensive use in public places or the healthcare sector.
- Detachable solid seat made from high-strength polymer.
- Uniform non-porous surface for easy maintenance and hygiene.
- Good resistance to chemical products and cleaning.
- Anti-UV treatment.
- Warm to the touch.
- Bacteriostatic 304 stainless steel structure Ø 32mm.
- Concealed fixings secured to wall by a 304 stainless steel plate, 4mm thick.
- Supplied with stainless steel screws for concrete walls.
- Tested to over 200kg. Maximum recommended user weight: 135kg.
- 10-year warranty.
- CE marked.



HR Comfort backrest

- For shower seats ref. 510420N and 510430N.
- Dimensions: 56 × 420 × 410mm.
- Detachable solid backrest made from high-strength polymer.



HR Comfort shower seat

- Dimensions: 506 × 420 × 138mm.
- Folded dimensions: 95 × 540mm.

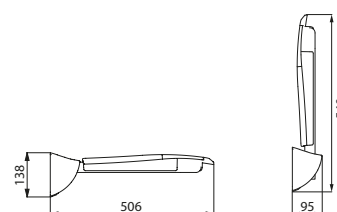

510420N

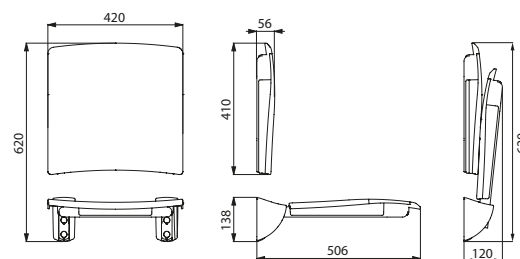

510434N

Lift-up Comfort shower seat - White powder-coated stainless steel structure	
Shower seat only	510420N
Backrest only	510429N
Shower seat with backrest	510434N

Lift-up shower seat with leg



- **HR Comfort shower seat and backrest.**
- **Large model.**
- Dimensions: 506 × 420 × 1,000mm.
- Folded dimensions: 165 × 620mm.
- **Retained in upright position.**
- **Slowed down descent.**
- Suitable for intensive use in public places or the healthcare sector.
- Detachable solid seat made from high-strength polymer.
- Uniform non-porous surface for easy maintenance and hygiene.
- Good resistance to chemical products and cleaning.
- Anti-UV treatment.
- Warm to the touch.
- Bacteriostatic 304 stainless steel structure Ø 32mm.
- **Reinforced by a folding, articulated leg** made from 304 stainless steel tube Ø 25mm.
- Concealed fixings secured to wall by a 304 stainless steel plate, 4mm thick.
- Supplied with stainless steel screws for concrete walls.
- **Tested to over 300kg. Maximum recommended user weight: 170kg.**
- 10-year warranty.
- CE marked.



HR Comfort backrest

- For shower seats refs. 510420N and 510430N.
- Dimensions: 56 × 420 × 410mm.
- Detachable solid backrest made from high-strength polymer.



HR Comfort shower seat with leg

- Dimensions: 506 × 420 × 480mm.
- Folded dimensions: 130 × 540mm.

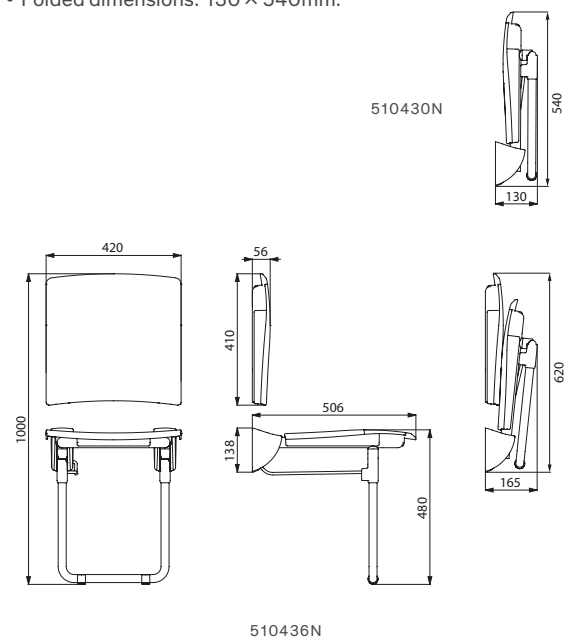

Lift-up Comfort shower seat with leg - White powder-coated stainless steel structure	
Shower seat with leg only	510430N
Backrest only	510429N
Shower seat with leg and backrest	510436N

Angled grab bar 135°

220 × 220mm



CE

- For WCs, showers or baths.
- For use as a handrail (horizontal part) or as a grab bar (135° part).
- Universal for either left or right side.
- Dimensions: 220 × 220mm, Ø 32mm.
- Suitable for intensive use in public places or the healthcare sector.
- High-strength polyamide (Nylon):
 - with 2mm reinforced steel core treated against corrosion.
- Uniform non-porous surface for easy maintenance and hygiene.
- Good resistance to chemical products and cleaning.
- Anti-UV treatment.
- Warm to the touch.
- 38mm gap between the bar and the wall:
 - minimal space prevents the forearm passing between the bar and the wall, reducing the risk of fracture in case of loss of balance.
- **3 fixing points prevent the hand from getting trapped and simplify installation.**
- Concealed fixings, secured to wall by a 6-hole plate, Ø 73mm.
- Supplied with stainless steel screws for concrete walls.
- Tested to over 200kg. Maximum recommended user weight: 135kg.
- 10-year warranty.
- CE marked.

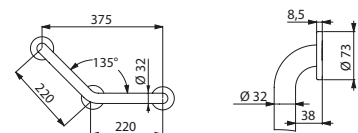

Angled grab bar 135° Ø 32mm - HR Nylon bright white - 220 × 220mm

5083N

5083N

Angled grab bar 135°

400 × 400mm



- For WCs, showers or baths.
- For use as a handrail (horizontal part) or as a grab bar (135° part).
- Universal for either left or right side.
- Dimensions: 400 × 400mm, Ø 32mm.
- Suitable for intensive use in public places or the healthcare sector.
- High-strength polyamide (Nylon): with 2mm reinforced steel core treated against corrosion.
- Uniform non-porous surface for easy maintenance and hygiene.
- Good resistance to chemical products and cleaning.
- Anti-UV treatment.
- Warm to the touch.
- 38mm gap between the bar and the wall: minimal space prevents the forearm passing between the bar and the wall, reducing the risk of fracture in case of loss of balance.
- **3 fixing points prevent the hand from getting trapped and simplify installation.**
- Concealed fixings, secured to wall by a 6-hole plate, Ø 73mm.
- Supplied with stainless steel screws for concrete walls.
- Tested to over 200kg. Maximum recommended user weight: 135kg.
- 10-year warranty.
- CE marked.

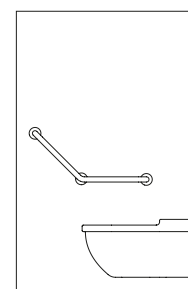

Installation example for WCs

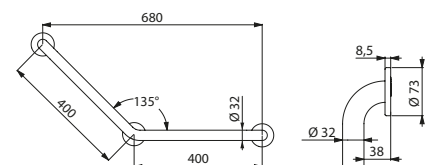

Angled grab bar 135° Ø 32mm - HR Nylon bright white - 400 × 400mm	5081N
---	-------

5081N

Straight grab bar



- For WCs, showers or baths.
- For use as a handrail and grab or support bar.
- Dimensions: 300 - 900mm centre-to-centre, Ø 32mm.
- Suitable for intensive use in public places or the healthcare sector.
- High-strength polyamide (Nylon):
with 2mm reinforced steel core treated against corrosion.
- Uniform non-porous surface for easy maintenance and hygiene.
- Good resistance to chemical products and cleaning.
- Anti-UV treatment.
- Warm to the touch.
- 38mm gap between the bar and the wall:
minimal space prevents the forearm passing between the bar and the wall,
reducing the risk of fracture in case of loss of balance.
- Concealed fixings, secured to wall by a 6-hole plate, Ø 73mm.
- Supplied with stainless steel screws for concrete walls.
- Tested to over 200kg. Maximum recommended user weight: 135kg.
- 10-year warranty.
- CE marked.

Straight grab bar Ø 32mm	
HR Nylon bright white - 300mm	5050N
HR Nylon bright white - 400mm	50504N
HR Nylon bright white - 500mm	50505N
HR Nylon bright white - 600mm	50506N
HR Nylon bright white - 900mm	50509N

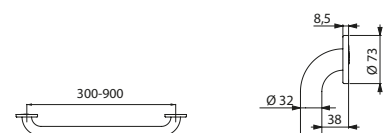

5050N/50504N/50505N/50506N/50509N

Wall support rail



- For WCs, showers or washbasins.
- For use as a grab bar and a fixed support rail.
- Generally installed parallel to a drop-down support rail in a WC or on either side of a washbasin.
- Recommended if the WC pan or shower seat is a long way from the side wall.
- Dimensions: 650 × 230 × 105mm, Ø 32mm.
- Suitable for intensive use in public places or the healthcare sector.
- High-strength polyamide (Nylon):
with 2mm reinforced steel core treated against corrosion.
- Uniform non-porous surface for easy maintenance and hygiene.
- Good resistance to chemical products and cleaning.
- Anti-UV treatment.
- Warm to the touch.
- Fixings concealed by a 304 stainless steel cover plate, 4mm thick.
- Supplied with stainless steel screws for concrete walls.
- Tested to over 200kg. Maximum recommended user weight: 135kg.
- 10-year warranty.
- CE marked.

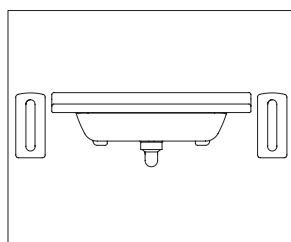

Installation example either side of a washbasin

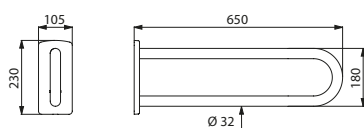

5161N

Additional products



Backrest for WCs and toilet roll holder
(see pages 143 and 145)

Drop-down support rail

Without leg

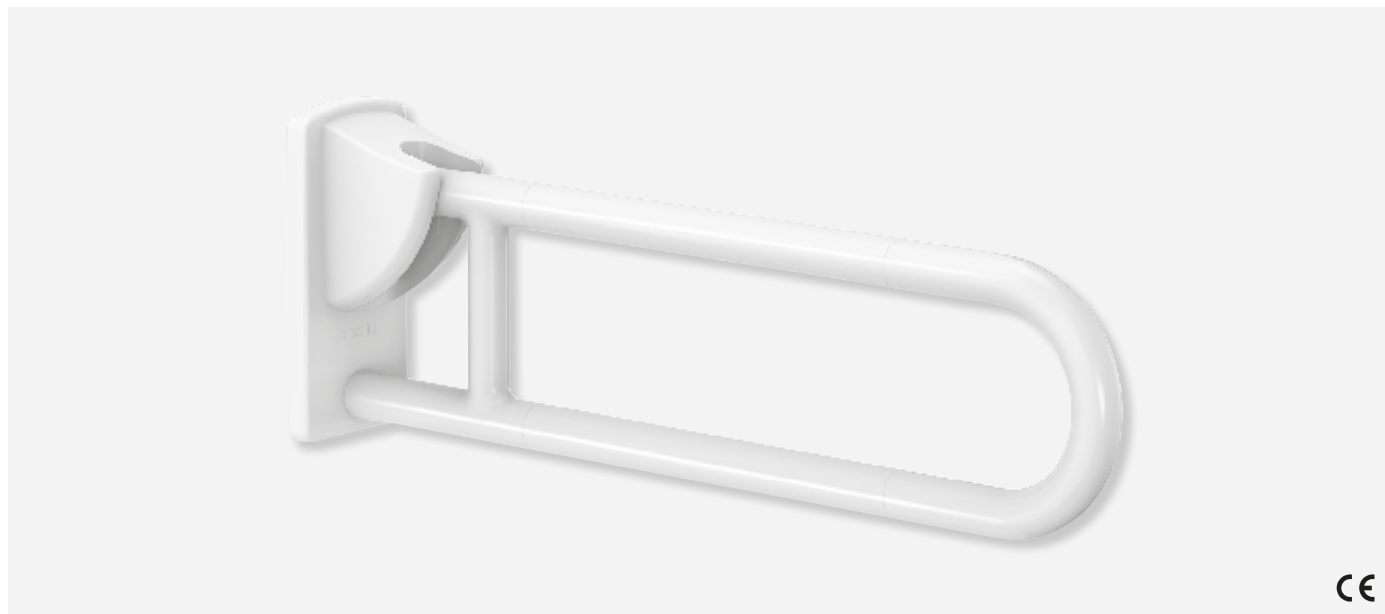

- For WCs or showers.
- Allows side access in the raised position.
- In the lowered position use as a grab bar, as a support for standing and for assisting movement.
- Dimensions: 850 or 650 × 230 × 105mm, Ø 32mm.
- Retained in upright position.
- Slowed down descent.
- Suitable for intensive use in public places or the healthcare sector.
- High-strength polyamide (Nylon) and polymer: with 2mm reinforced steel core treated against corrosion.
- Uniform non-porous surface for easy maintenance and hygiene.
- Good resistance to chemical products and cleaning.
- Anti-UV treatment.
- Warm to the touch.
- Fixings, secured to wall by a 4mm thick 304 stainless steel plate, concealed by cover plate.
- Supplied with stainless steel screws for concrete walls.
- Tested to over 200kg. Maximum recommended user weight: 135kg.
- 10-year warranty.
- CE marked.

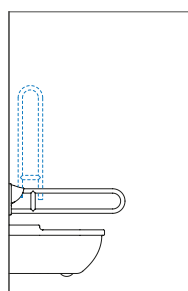

Installation example for WCs

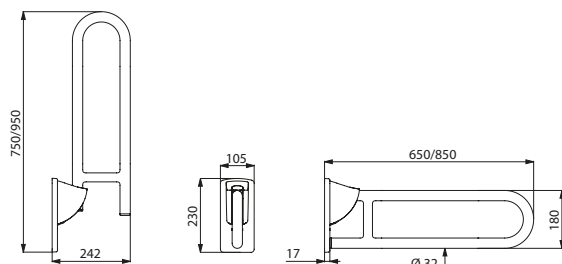

5160N/5164N

Additional products



Backrest for WCs and toilet roll holder (see pages 143 and 145)

Related product

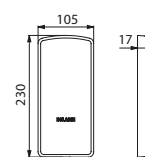

510150N

Cover plate

- Conceals the fixing screws when the drop-down support rail is removed.
- Reduces the number of rails in a facility, allowing installation only when required e.g. hotels or hospitals accommodating a disabled person temporarily.
- Supplied with stainless steel screws for concrete walls.

Drop-down support rail Ø 32mm	
HR Nylon bright white - L. 650mm	5160N
HR Nylon bright white - L. 850mm	5164N

Nylon cover with fixing plate	510150N
-------------------------------	---------

Drop-down support rail

With leg



- For WCs or showers.
- Allows side access in the raised position.
- In the lowered position use as a grab bar, as a support for standing and for assisting movement.
- With automatic folding leg. To be used as reinforcement when the wall fixing alone is insufficient.
- Leg height can be adjusted from 760 - 780mm.
- Dimensions : 850 or 650 × 800 × 105mm, Ø 32mm.
- Retained in upright position.
- Slowed down descent.
- Suitable for intensive use in public places or the healthcare sector.
- High-strength polyamide (Nylon) and polymer: with 2mm reinforced steel core treated against corrosion.
- Uniform non-porous surface for easy maintenance and hygiene.
- Good resistance to chemical products and cleaning.
- Anti-UV treatment.
- Warm to the touch.
- Fixings, secured to wall by a 4mm thick 304 stainless steel plate, concealed by cover plate.
- Supplied with stainless steel screws for concrete walls.
- Tested to over 200kg.
- Maximum recommended user weight: 135kg.
- 10-year warranty.
- CE marked.

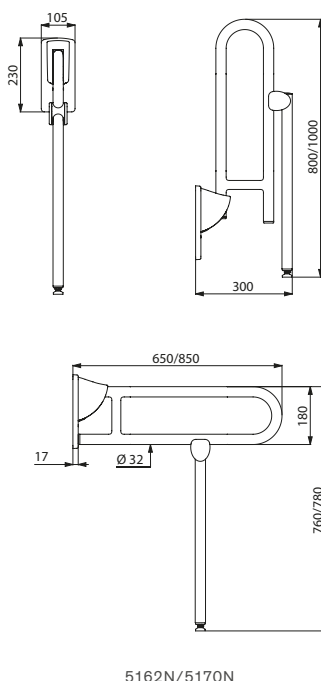

5162N/5170N

Additional products



Backrest for WCs and toilet roll holder (see pages 143 and 145)

Related product



Cover plate

- Conceals the fixing screws when the drop-down support rail is removed.
- Reduces the number of rails in a facility, allowing installation only when required e.g. hotels or hospitals accommodating a disabled person temporarily.
- Supplied with stainless steel screws for concrete walls.

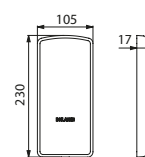

510150N

Drop-down support rail Ø 32mm with leg	
HR Nylon bright white - L. 650mm	5162N
HR Nylon bright white - L. 850mm	5170N

Nylon cover with fixing plate	510150N
-------------------------------	---------

Straight bar with sliding shower head holder



Additional products



Sliding soap dish and shower head (see page 143)

- For showers or baths.
- Can be used as a vertical grab bar and a shower head rail.
- HR Nylon sliding shower head holder with ergonomic locking ring.
- Sliding soap dish can be added (order separately).
- Height: 1,150mm, Ø 32mm.
- Suitable for intensive use in public places or the healthcare sector.
- High-strength polyamide (Nylon):
with 2mm reinforced steel core treated against corrosion.
- Uniform non-porous surface for easy maintenance and hygiene.
- Good resistance to chemical products and cleaning.
- Anti-UV treatment.
- Warm to the touch.
- 38mm gap between the bar and the wall:
minimal space prevents the forearm passing between the bar and the wall,
reducing the risk of fracture in case of loss of balance.
- Concealed fixings, secured to wall by a 6-hole plate, Ø 73mm.
- Supplied with stainless steel screws for concrete walls.
- Tested to over 200kg. Maximum recommended user weight: 135kg.
- 10-year warranty.
- CE marked.

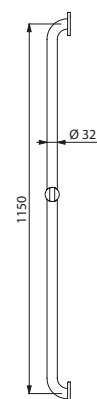
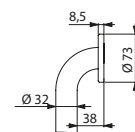

Straight bar Ø 32mm with sliding shower head holder
HR Nylon bright white H. 1,150mm

5460N

5460N

Right angled shower grab bar



- For showers.
- Use as a grab bar and to support the user in an upright position.
- Helps and secures entry and movement in the shower.
- Use as a shower rail by adding a sliding shower head holder and/or soap dish.
- Can be installed with the upright to the left or right side.
- Dimensions: 1,245 × 570 × 660mm, Ø 32mm.
- Suitable for intensive use in public places or the healthcare sector.
- High-strength polyamide (Nylon): with 2mm reinforced steel core treated against corrosion.
- Uniform non-porous surface for easy maintenance and hygiene.
- Good resistance to chemical products and cleaning.
- Anti-UV treatment.
- Warm to the touch.
- 38mm gap between the bar and the wall: minimal space prevents the forearm passing between the bar and the wall, reducing the risk of fracture in case of loss of balance.
- Concealed fixings, secured to wall by a 6-hole plate, Ø 73mm.
- Supplied with stainless steel screws for concrete walls.
- Tested to over 200kg. Maximum recommended user weight: 135kg.
- 10-year warranty.
- CE marked.

Additional products

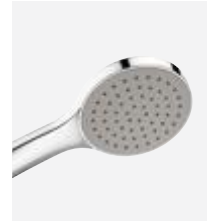
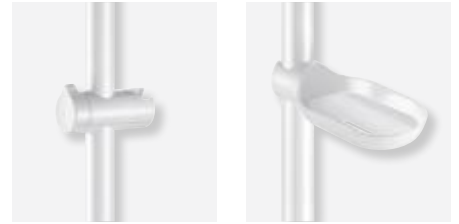

Sliding shower head holder, sliding soap dish and shower head (see page 143)

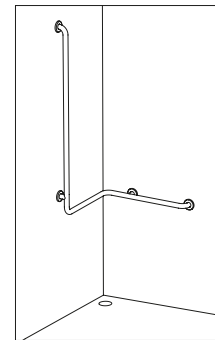

Installation example for showers

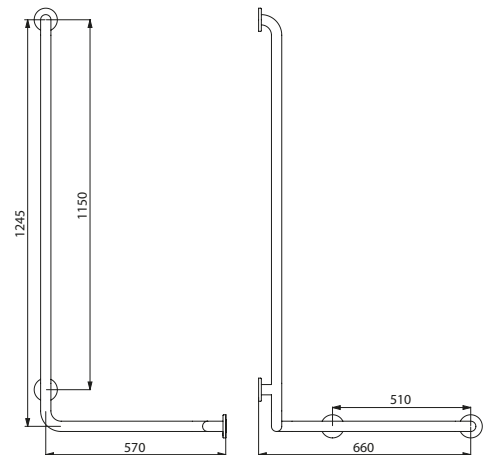
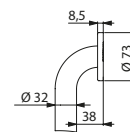

Right angled shower grab bar Ø 32mm - HR Nylon bright white

5100N

5100N



Lift-up Comfort seat **510434N** - SECURITHERM BIOSAFE thermostatic mixer **H9769** - L-shaped grab bar **5071N** - Sliding shower head holder **510110**
Soap dish **510120N** - Coat hooks **4043N**

L-shaped grab bar



Additional products

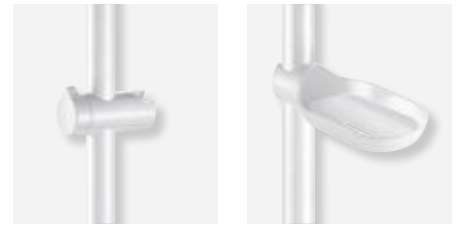

Sliding shower head holder, sliding soap dish and shower head (see page 143)

- For showers or baths.
- Helps the user stand and move safely in the shower or bath.
- Use as a shower rail by adding a sliding shower head holder and/or soap dish.
- Can be installed with the upright to the left or right side.
- Dimensions: 1,245 or 750 × 450mm, Ø 32mm.
- Suitable for intensive use in public places or the healthcare sector.
- High-strength polyamide (Nylon):
with 2mm reinforced steel core treated against corrosion.
- Uniform non-porous surface for easy maintenance and hygiene.
- Good resistance to chemical products and cleaning.
- Anti-UV treatment.
- Warm to the touch.
- 38mm gap between the bar and the wall:
minimal space prevents the forearm passing between the bar and the wall, reducing the risk of fracture in case of loss of balance.
- Concealed fixings, secured to wall by a 6-hole plate, Ø 73mm.
- Supplied with stainless steel screws for concrete walls.
- Tested to over 200kg. Maximum recommended user weight: 135kg.
- 10-year warranty.
- CE marked.

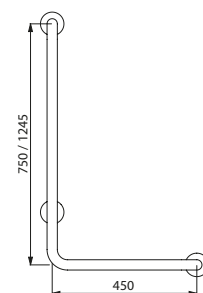
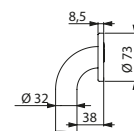

5070N/5071N

L-shaped grab bar Ø 32mm	
HR Nylon bright white - H. 750mm	5070N
HR Nylon bright white - H. 1,245mm	5071N

T-shaped grab bar



Additional products

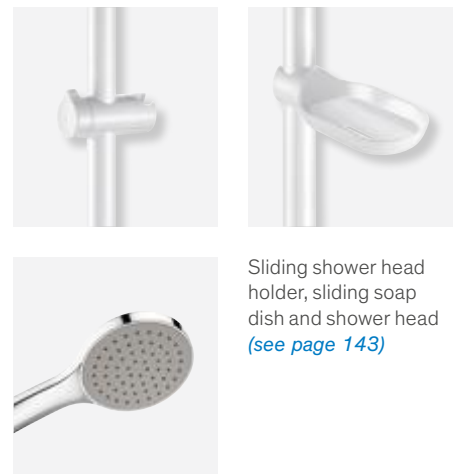

Sliding shower head holder, sliding soap dish and shower head (see page 143)

- For showers.
- Use as a grab bar and to support the user in an upright position.
- Helps and secures entry and movement in the shower.
- Use as a shower rail by adding a sliding shower head holder and/or soap dish.
- Dimensions: 1,150 × 500mm, Ø 32mm.
- Suitable for intensive use in public places or the healthcare sector.
- High-strength polyamide (Nylon): with 2mm reinforced steel core treated against corrosion.
- Uniform non-porous surface for easy maintenance and hygiene.
- Good resistance to chemical products and cleaning.
- Anti-UV treatment.
- Warm to the touch.
- 38mm gap between the bar and the wall: minimal space prevents the forearm passing between the bar and the wall, reducing the risk of fracture in case of loss of balance.
- Concealed fixings, secured to wall by a 6-hole plate, Ø 73mm.
- Supplied with stainless steel screws for concrete walls.
- Tested to over 200kg. Maximum recommended user weight: 135kg.
- 10-year warranty.
- CE marked.

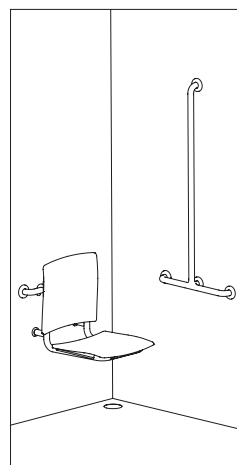

Installation example for showers

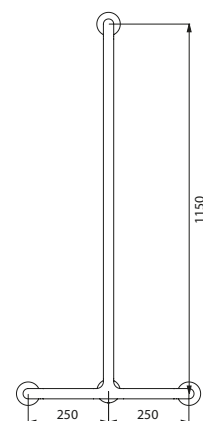
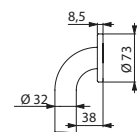

T-shaped grab bar with sliding vertical bar



Additional products

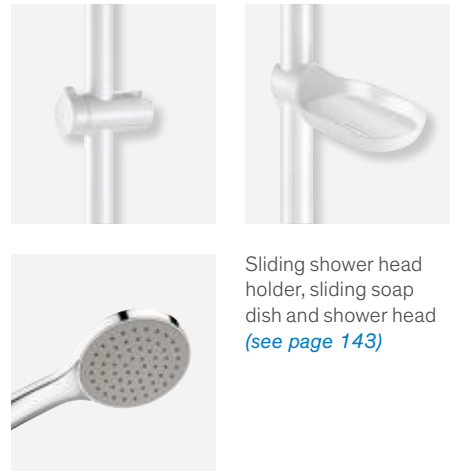

Sliding shower head holder, sliding soap dish and shower head (see page 143)

- For showers.
- Use as a grab bar and to support the user in an upright position.
- Helps and secures entry and movement in the shower.
- Use as a shower rail by adding a sliding shower head holder and/or soap dish.
- Upright position can be adjusted during installation: can be moved to the left or the right in order to adapt the space (positioning of shower, depth of shower seat...).
- Dimensions: 1,150 × 500mm, Ø 32mm.
- Suitable for intensive use in public places or the healthcare sector.
- High-strength polyamide (Nylon): with 2mm reinforced steel core treated against corrosion.
- Uniform non-porous surface for easy maintenance and hygiene.
- Good resistance to chemical products and cleaning.
- Anti-UV treatment.
- Warm to the touch.
- 38mm gap between the bar and the wall: minimal space prevents the forearm passing between the bar and the wall, reducing the risk of fracture in case of loss of balance.
- Concealed fixings, secured to wall by a 6-hole plate, Ø 73mm.
- Supplied with stainless steel screws for concrete walls.
- Tested to over 200kg. Maximum recommended user weight: 135kg.
- 10-year warranty.
- CE marked.

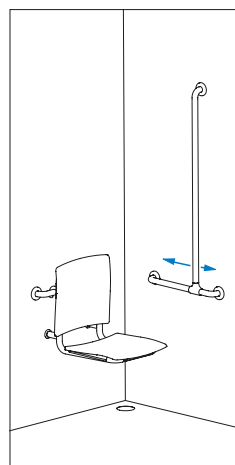

Upright can be moved

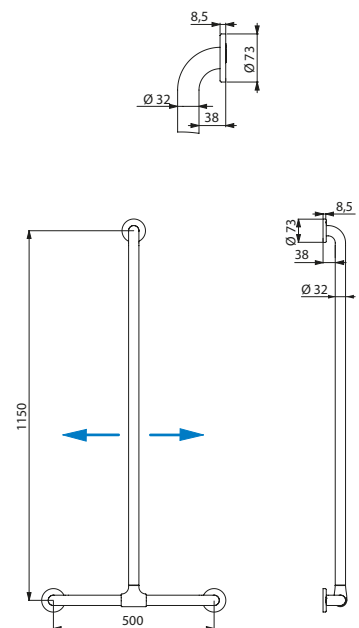

5441N

Provisional availability 1st half 2019. Please contact sales office to check availability.

T-shaped grab bar with sliding vertical bar Ø 32mm - HR Nylon bright white	5441N
--	-------

Two-wall corner grab bar with vertical bar

For shower seats



- For showers.
- Can support a removable shower seat (order separately).
- Use as a grab bar and to support the user in an upright position.
- Helps and secures entry and movement in the shower.
- Use as a shower rail by adding a sliding shower head holder and/or soap dish.
- Can be installed with the upright to the left or right side.
- Dimensions: 1,150 × 750 × 750mm, Ø 32mm.
- Suitable for intensive use in public places or the healthcare sector.
- High-strength polyamide (Nylon): with 2mm reinforced steel core treated against corrosion.
- Uniform non-porous surface for easy maintenance and hygiene.
- Good resistance to chemical products and cleaning.
- Anti-UV treatment.
- Warm to the touch.
- 38mm gap between the bar and the wall: minimal space prevents the forearm passing between the bar and the wall, reducing the risk of fracture in case of loss of balance.
- Concealed fixings, secured to wall by a 6-hole plate, Ø 73mm.
- Supplied with stainless steel screws for concrete walls.
- Tested to over 200kg. Maximum recommended user weight: 135kg.
- 10-year warranty.
- CE marked.

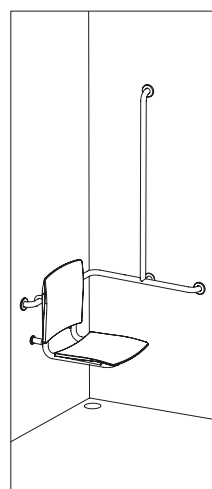

Installation example for showers

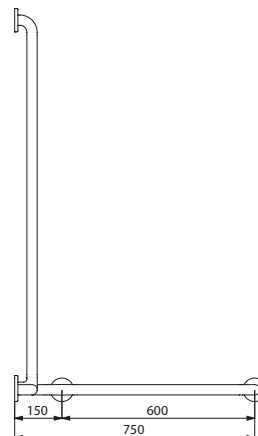
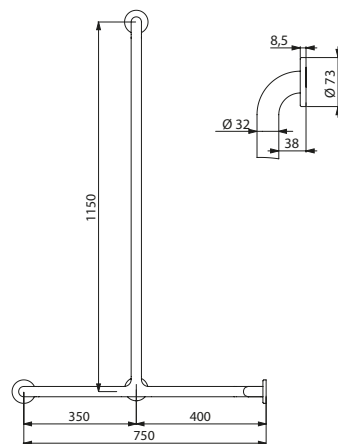

Additional products

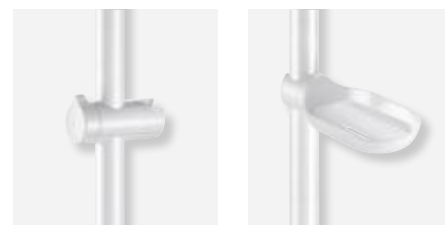

Removable shower seat (see page 123), sliding shower head holder and sliding soap dish (see page 143)

Two-wall corner grab bar with vertical bar Ø 32mm
HR Nylon bright white - For shower seats

5490N

5490N

Two-wall grab bar with sliding vertical bar

For shower seats



- For showers.
- Can support a removable shower seat (order separately).
- Use as a grab bar and to support the user in an upright position.
- Helps and secures entry and movement in the shower.
- Use as a shower rail by adding a sliding shower head holder and/or soap dish.
- Upright position can be adjusted during installation: can be moved to the left or the right in order to adapt the space (positioning of shower, depth of shower seat...).
- Can be installed with the upright on the left or the right.
- Dimensions: 1,150 × 750 × 750mm, Ø 32mm.
- Suitable for intensive use in public places or the healthcare sector.
- High-strength polyamide (Nylon): with 2mm reinforced steel core treated against corrosion.
- Uniform non-porous surface for easy maintenance and hygiene.
- Good resistance to chemical products and cleaning.
- Anti-UV treatment.
- Warm to the touch.
- 38mm gap between the bar and the wall: minimal space prevents the forearm passing between the bar and the wall, reducing the risk of fracture in case of loss of balance.
- Concealed fixings, secured to wall by a 6-hole plate, Ø 73mm.
- Supplied with stainless steel screws for concrete walls.
- Tested to over 200kg. Maximum recommended user weight: 135kg.
- 10-year warranty.
- CE marked.

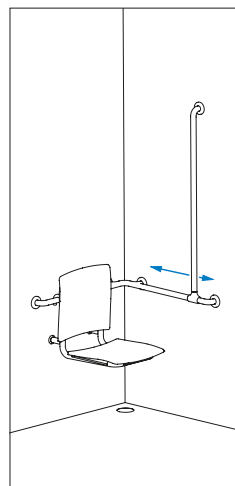

Upright can be moved to the left or the right

Additional products



Removable shower seat (see page 123), sliding shower head holder and sliding soap dish (see page 143)

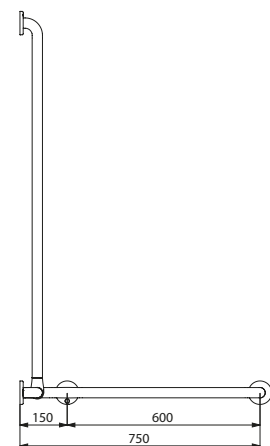
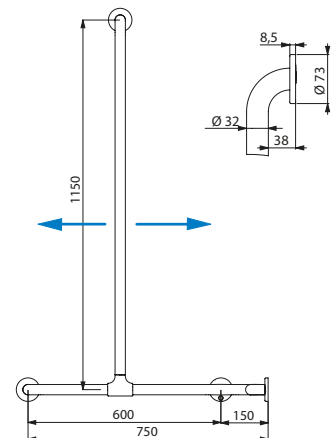

5481N

Provisional availability 1st half 2019. Please contact sales office to check availability.

Two-wall grab bar with sliding vertical bar Ø 32mm
HR Nylon bright white - For shower seats

5481N

Two-wall corner grab bar

For shower seats



CE

- For WCs, showers or baths.
- Can support a removable shower seat (order separately).
- Use as a grab bar and to support the user in an upright position.
- Helps and secures entry and movement in the shower or bath.
- Helps with the transfer from a wheelchair to the toilet seat for WCs with recessed cisterns or direct flush.
- Dimensions: 750 × 750mm, Ø 32mm.
- Suitable for intensive use in public places or the healthcare sector.
- High-strength polyamide (Nylon):
with 2mm reinforced steel core treated against corrosion.
- Uniform non-porous surface for easy maintenance and hygiene.
- Good resistance to chemical products and cleaning.
- Anti-UV treatment.
- Warm to the touch.
- 38mm gap between the bar and the wall:
minimal space prevents the forearm passing between the bar and the wall, reducing the risk of fracture in case of loss of balance.
- Concealed fixings, secured to wall by a 6-hole plate, Ø 73mm.
- Supplied with stainless steel screws for concrete walls.
- Tested to over 200kg. Maximum recommended user weight: 135kg.
- 10-year warranty.
- CE marked.

Additional product



CE

Removable shower seat (see page 123)

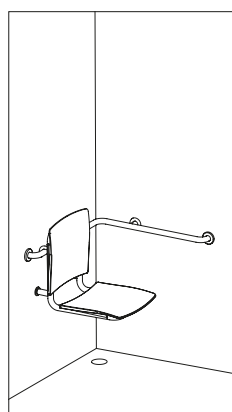

Installation example for showers

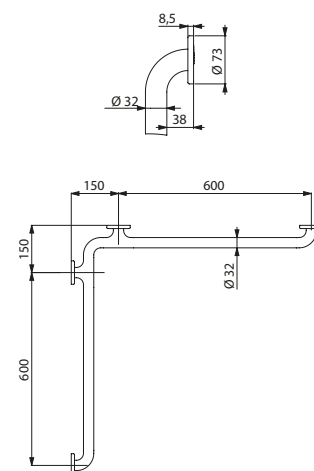

Single grab bar

For shower seats



CE

- For showers.
- Can support a removable shower seat (order separately).
- Use as a support rail and to support the user in an upright position.
- Helps and secures entry and movement in the shower.
- Dimensions: 400mm, Ø 32mm.
- Suitable for intensive use in public places or the healthcare sector.
- High-strength polyamide (Nylon):
with 2mm reinforced steel core treated against corrosion.
- Uniform non-porous surface for easy maintenance and hygiene.
- Good resistance to chemical products and cleaning.
- Anti-UV treatment.
- Warm to the touch.
- 38mm gap between the bar and the wall:
minimal space prevents the forearm passing between the bar and the wall,
reducing the risk of fracture in case of loss of balance.
- Concealed fixings, secured to wall by a 6-hole plate, Ø 73mm.
- Supplied with stainless steel screws for concrete walls.
- Tested to over 200kg. Maximum recommended user weight: 135kg.
- 10-year warranty.
- CE marked.

Additional product



CE

Removable shower seat (see page 123)

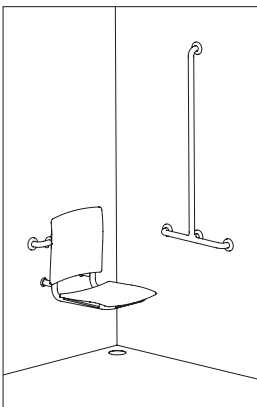

Installation example
for showers

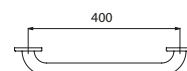
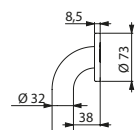

50504N

Grab bar Ø 32mm - HR Nylon bright white - For shower seats

50504N

Lift-up shower curtain rail



- Allows side access in the raised position.
- Preserves the patient's privacy in the lowered position.
- Allows a carer to assist with bathing a patient while protecting them from splashes.
- Dimensions: 900 × 230 × 105mm, Ø 32mm.
- Retained in upright position.
- Slowed down descent.
- High-strength polyamide (Nylon):
with 2mm reinforced steel core treated against corrosion.
- Fixings, secured to wall by a 4mm thick 304 stainless steel plate, concealed by cover plate.
- Supplied with stainless steel screws for concrete walls.
- 10-year warranty.

Related product

Shower curtain



- Material: polyester.
- Bottom of curtain is weighted.
- Dimensions: L. 880 × H. 790mm.
- Supplied with 6 plastic curtain rings.

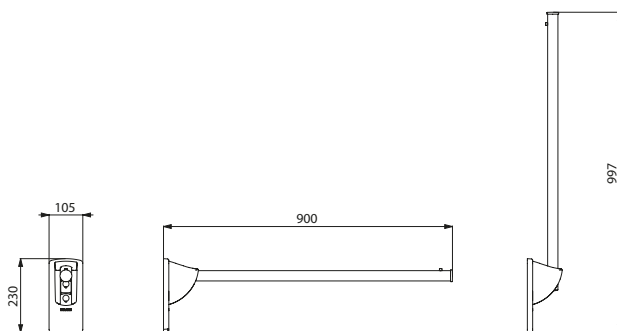

510159N

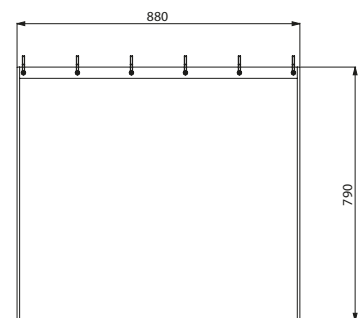

510158

Lift-up shower curtain rail - HR Nylon bright white

510159N

Shower curtain with 6 curtain rings

510158

Sliding shower head holder



- High-strength polyamide (Nylon).
- Support for adjustable shower heads.
- Ergonomic locking ring.
- **For Ø 32mm grab bars.**

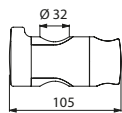

510110

Sliding shower head holder - HR Nylon bright white 510110

Clip-on sliding soap dish



- High-strength polyamide (Nylon).
- Soap dish for shower gel or soap.
- **For Ø 25 and Ø 32mm grab bars.**

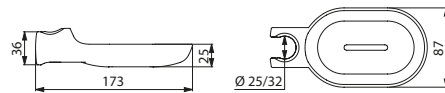

510120N

Clip-on soap dish - HR Nylon bright white 510120N

Shower head



- M¹/₂" shower head in chrome-plated ABS.
- Monojet: rain effect.
- Manual system for removing limescale.

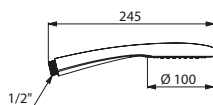

815

Rain effect shower head 815

Toilet roll holder for grab bars

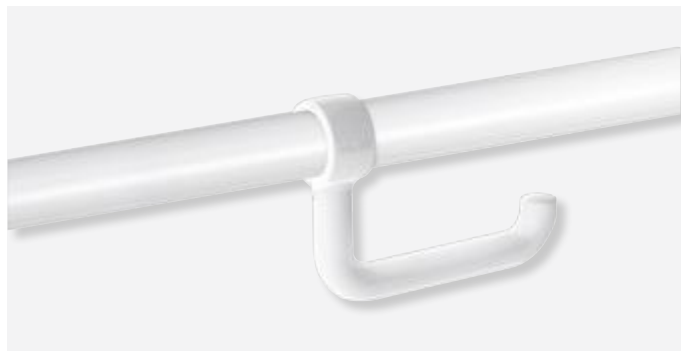

- High-strength polyamide (Nylon).
- Can be fitted without removing the grab bar.
- Locks in place to prevent theft.
- Anti-rotating locking feature.
- **For Ø 32 - 34mm grab bars.**

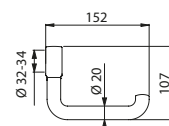

510081N

Toilet roll holder for grab bars - HR Nylon bright white 510081N

Coat hook



- High-strength polyamide (Nylon).
- Tube Ø 20mm.
- **Concealed fixings.**

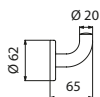

4043N

Coat hook - HR Nylon bright white	4043N
-----------------------------------	-------

Double coat hook



- White powder-coated 304 stainless steel.
- Tube Ø 20mm, 1mm thick.
- **Concealed fixings.**

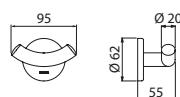

4042W

Double coat hook White powder-coated 304 st. steel	4042W
---	-------

U-shaped toilet roll holder

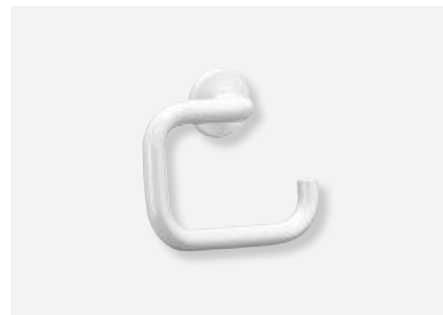

- High-strength polyamide (Nylon).
- Tube Ø 20mm.
- **Concealed fixings.**

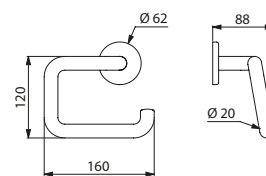

4081N

U-shaped toilet roll holder HR Nylon bright white	4081N
--	-------

Single coat hook

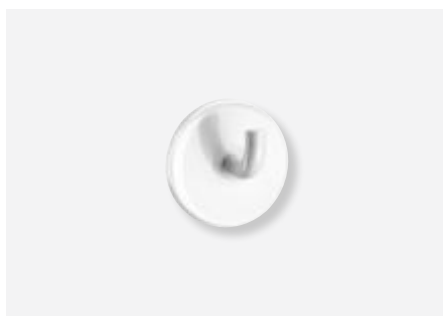

- High-strength polyamide (Nylon).
- Tube Ø 10mm.
- **Concealed fixings.**

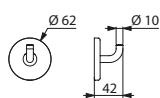

510043N

Single coat hook HR Nylon bright white	510043N
---	---------

Double coat hook



- High-strength polyamide (Nylon).
- Tube Ø 10mm.
- **Concealed fixings.**

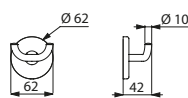

510042N

Double coat hook HR Nylon bright white	510042N
---	---------

Spare toilet roll holder



- High-strength polyamide (Nylon).
- Tube Ø 32mm.
- **Concealed fixings.**

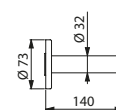

4070N

Spare toilet roll holder HR Nylon bright white	4070N
---	-------

Toilet brush set

With anti-theft lock and long handle



Toilet brush set HR Nylon bright white with long handle Anti-theft lock	4051N
--	-------

- High-strength polyamide (Nylon).
- Long, ergonomic handle: easy for wheelchair users or people who have difficulty bending to use.
- Easy to clean: plastic bowl can be removed from above.
- Plastic bowl with reservoir: prevents toilet brush sitting in residual water and reduces the risk of splashing when next used.
- Wall-mounted with anti-theft lock.
- Height: 515mm.

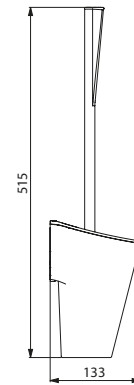

4051N

Toilet booster seat with lid



- White plastic with side fixing.
- Width can be adjusted from 320 to 380mm.
- Supports weights up to 225kg.
- CE marked.

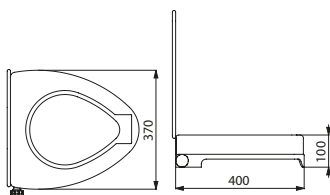

435

Toilet booster seat with lid	435
------------------------------	-----

Comfort backrest for WCs



- Backrest made from soft polyurethane.
- High-strength polyamide (Nylon) tube, Ø 32mm.
- Concealed fixings, secured to wall by a 6-hole plate, Ø 73mm.
- Dimensions: 150 × 575 × 173mm.
- CE marked.

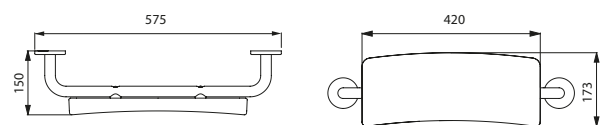

510629N

Comfort backrest for WCs - HR Nylon bright white	510629N
--	---------



Tilting mirror with long, ergonomic lever



- **For combined installation:** can be used from sitting or standing position.
- **Long, ergonomic lever for easy adjustment of mirror angle from a sitting position or from a wheelchair.**
- **Quick and easy to install:** simply clip into place.
- **Anti-theft lock.**
- Bright white HR Nylon lever.
- Mirror made from 6mm Securit safety glass.
- Mirror dimensions: 500 × 600mm.
- Can be tilted up to 20°.

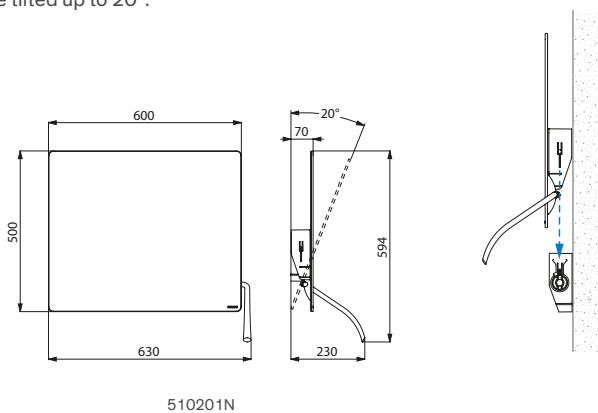

Tilting mirror with tab handle



- **For combined installation:** can be used from sitting or standing position.
- **Tab handle for easy adjustment of mirror angle for those in a sitting position or for wheelchair users.**
- **Quick and easy to install:** simply clip into place.
- **Anti-theft lock.**
- Bright white HR Nylon handle.
- Mirror made from 6mm Securit safety glass.
- Mirror dimensions: 500 × 600mm.
- Can be tilted up to 20°.

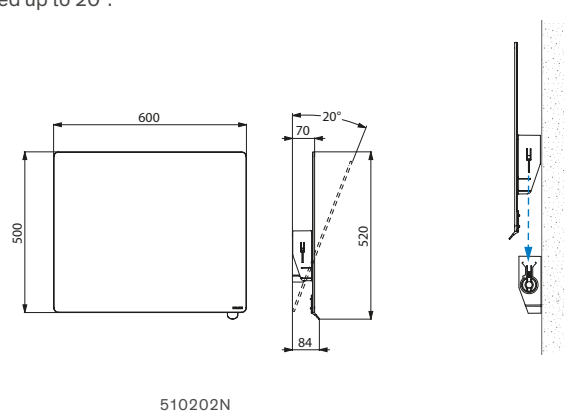

Tilting mirror with long, ergonomic white HR Nylon lever **510201N**
 For more mirrors and studded pegs see pages 41-43.

Tilting mirror with white HR Nylon tab handle **510202N**
 For more mirrors and studded pegs see pages 41-43.

MINERALCAST PMR washbasin



- Wall-mounted washbasin, 785 × 545 × 150mm.
- **With integral side grips** which can be used as a support or a towel holder.
- MINERALCAST: composite material consisting of natural minerals and polyester resin.
- **Shallow washbasin suitable for wheelchair users and use from a sitting position.**
- Uniform non-porous surface is easy to clean.
- One-piece cast washbasin, seam-free, for easy maintenance and better hygiene.
- Warm to the touch.
- Without overflow.
- Supplied with fixing elements.
- Weight: 21.5kg.

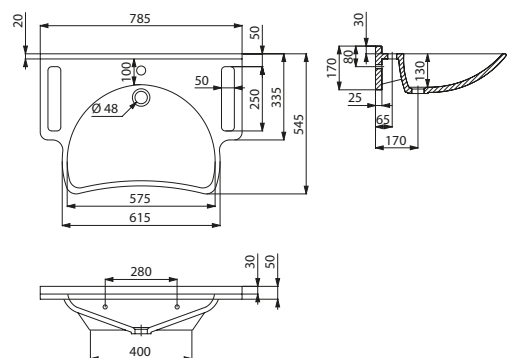

Wall-mounted MINERALCAST PMR washbasin with central tap hole Ø 35mm

132306

132306



Accessibility and Independence

Basic and ECO Ranges

SEATS
& STOOL
152



WHITE
BASIC
GRAB BARS
154

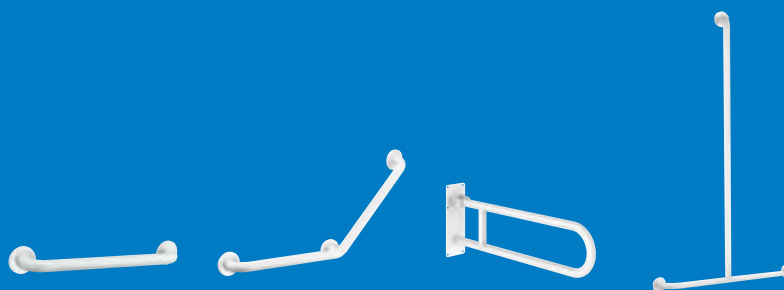

SATIN FINISH
BASIC
GRAB BARS
157



ECO
GRAB
BARS
158



ALU lift-up shower seat with leg - Large model



- **Large model.**
- Dimensions: 430 × 465 × 480mm.
- Folded dimensions: 82 × 565mm.
- Seat height: 480mm.
- Leg height can be adjusted up to 8mm.
- **Ergonomic non-slip side grips.**
- **Large plastic slats are comfortable and easy to maintain.**
- Folding leg guided by an articulated arm.
- Structure made from white aluminium tube Ø 25 × 2mm.
- **Concealed fixings.**
- Tested to over 200kg. Maximum recommended user weight: 135kg.
- CE marked.

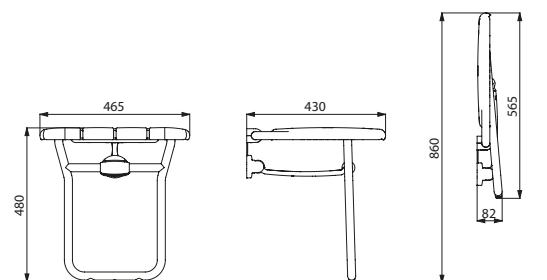

ALU lift-up shower seat with leg - Large model

510410

510410

ALU lift-up shower seat with leg



- Dimensions: 407 × 360 × 480mm.
- Folded dimensions: 82 × 545mm.
- Seat height: 480mm.
- **Large plastic slats are comfortable and easy to maintain.**
- Folding leg guided by an articulated arm.
- Structure made from white aluminium tube Ø 25 × 2mm.
- **Concealed fixings.**
- Tested to over 200kg. Maximum recommended user weight: 135kg.
- CE marked.

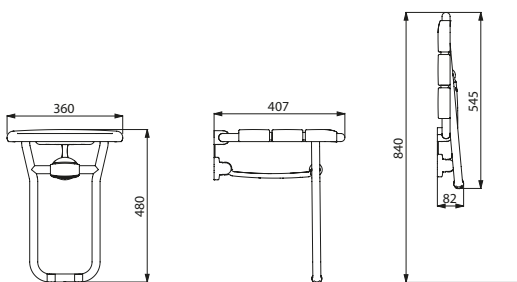

510400

ALU shower stool



- Dimensions: 400 × 360 × 480mm.
- Seat height: 480mm.
- **Large plastic slats are comfortable and easy to maintain.**
- Structure made from white aluminium tube Ø 25 × 2mm.
- Tested to over 200kg. Maximum recommended user weight: 135kg.
- Plastic protective feet.

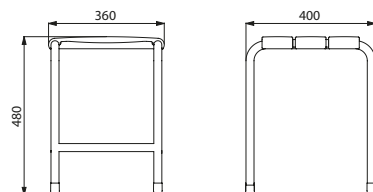

510418

ALU lift-up shower seat with leg

510400

ALU shower stool

510418

White powder-coated Basic straight grab bar

Tube Ø 32mm



- White powder-coated stainless steel.
- Concealed fixings, secured to wall by a 3-hole plate.
- CE marked.

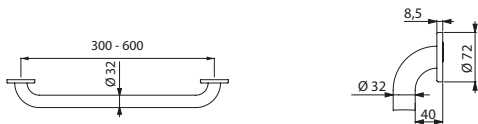

35050W/350504W/350505W/350506W

Basic straight grab bar Ø 32mm

White powder-coated stainless steel - 300mm	35050W
White powder-coated stainless steel - 400mm	350504W
White powder-coated stainless steel - 500mm	350505W
White powder-coated stainless steel - 600mm	350506W

White powder-coated Basic angled grab bar 135°

Tube Ø 32mm



- White powder-coated stainless steel.
- **3 fixing points prevent the hand from getting trapped and simplify installation.**
- Concealed fixings, secured to wall by a 3-hole plate.
- Dimensions: 400 × 400mm.
- CE marked.

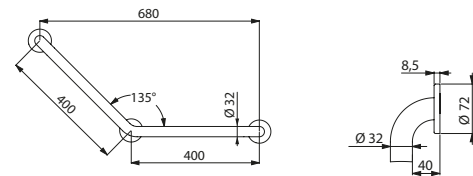

35082W

Basic angled grab bar 135° Ø 32mm
White powder-coated stainless steel

35082W

White powder-coated Basic T-shaped grab bar

Tube Ø 32mm



- White powder-coated stainless steel.
- Concealed fixings, secured to wall by a 3-hole plate.
- Dimensions: 1,150 × 500mm.
- CE marked.

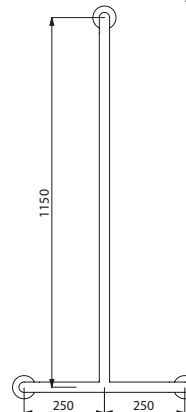
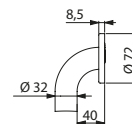

35440W

Basic T-shaped grab bar Ø 32mm
White powder-coated stainless steel

35440W



Sliding shower head holder and sliding soap dish
(see page 155)

Two-wall grab bar with sliding vertical bar Basic white powder-coated

Tube \varnothing 32mm



- White powder-coated stainless steel.
- **Upright position can be adjusted during installation:** can be moved to the left or the right.
- Can be installed with the upright on the left or the right.
- Concealed fixings, secured to wall by a 3-hole plate.
- Dimensions: 1,150 × 750 × 750mm.
- CE marked.

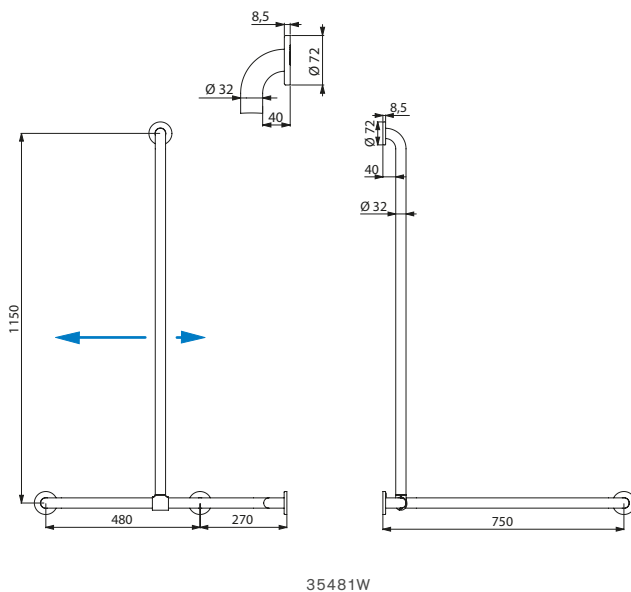

35481W

Provisional availability 2nd half 2019. Please contact sales office to check availability.

Basic two-wall grab bar with sliding vertical bar \varnothing 32mm White powder-coated stainless steel	35481W
---	--------

Related Products

Sliding shower head holder



- High-strength polyamide (Nylon).
- Support for adjustable shower heads.
- Ergonomic locking ring.
- **For \varnothing 32mm bars.**

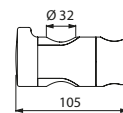

510110

Sliding holder HR Nylon bright white	510110
---	--------

Clip-on sliding soap dish



- High-strength polyamide (Nylon).
- Soap dish for shower gel or soap.
- **For \varnothing 25 and \varnothing 32mm grab bars.**

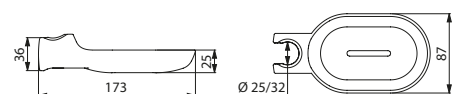

510120N

Clip-on soap dish HR Nylon bright white	510120N
--	---------

White powder-coated Basic drop-down support rail

Tube Ø 32mm



- White powder-coated stainless steel.
- Visible fixings, secured to wall by a 6-hole plate.
- Dimensions: 760 × 300 × 100mm.
- **Wall plate thickness: 3.5mm.**
- CE marked.

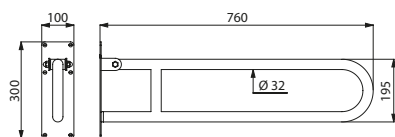

511516W

Basic drop-down support rail Ø 32mm - White powder-coated stainless steel

511516W

Related product

Toilet roll holder for grab bars



- High-strength polyamide (Nylon).
- Can be fitted without removing the grab bar.
- Locks in place to prevent theft.
- Anti-rotating locking feature.
- **For Ø 32 - Ø 34mm bars.**

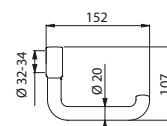

510081N

Toilet roll holder for grab bars
HR Nylon bright white

510081N

Drop-down support rail Basic white powder-coated

Tube Ø 32mm, with leg



- White powder-coated stainless steel.
- Visible fixings, secured to wall by a 6-hole plate.
- With automatic folding leg.
To be used as a reinforcement when the wall fixing alone is insufficient.
- Adjustable leg height from 760 to 780mm.
- Dimensions: 760 × 815 × 100mm.
- **Wall plate thickness: 3.5mm.**
- CE marked.



Toilet roll holder
(see above)

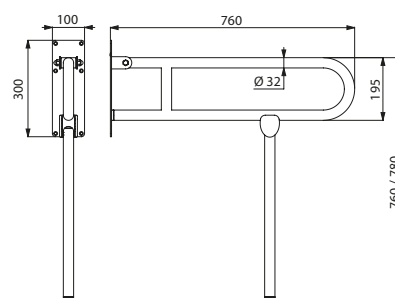

511517W

Provisional availability 2nd half 2019.
Please contact sales office to check availability.

Drop-down support rail Basic Ø 32mm with leg
White powder-coated stainless steel

511517W

Satin finish Basic straight grab bar

Tube Ø 32mm



- Polished satin 304 stainless steel.
- Concealed fixings, secured to wall by a 3-hole plate.
- CE marked.

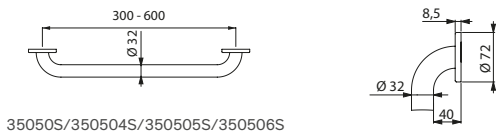

35050S/350504S/350505S/350506S

Basic straight grab bar Ø 32mm	
Polished satin 304 stainless steel - 300mm	35050S
Polished satin 304 stainless steel - 400mm	350504S
Polished satin 304 stainless steel - 500mm	350505S
Polished satin 304 stainless steel - 600mm	350506S

Satin finish Basic angled grab bar 135°

Tube Ø 32mm



- Polished satin 304 stainless steel.
- 3 fixing points prevent the hand from getting trapped and simplify installation.
- Concealed fixings, secured to wall by a 3-hole plate.
- Dimensions: 400 × 400mm.
- CE marked.

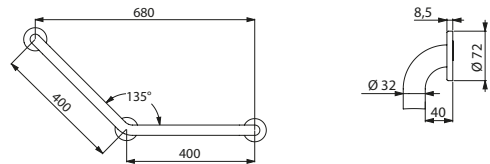

35082S

Basic angled grab bar 135° Ø 32mm Polished satin 304 stainless steel	35082S
---	---------------

Satin finish Basic drop-down support rail

Tube Ø 32mm



- Polished satin 304 stainless steel.
- Visible fixings, secured to wall by a 6-hole plate.
- Dimensions : 850 × 300 × 100mm.
- Wall plate thickness: 3.5mm.
- CE marked.

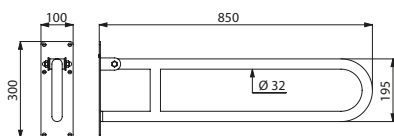

35164S

Drop-down support rail Basic Ø 32mm - Polished satin 304 stainless steel	35164S
--	---------------

Related product

Toilet roll holder for grab bars



- High-strength polyamide (Nylon).
- Can be fitted without removing the grab bar.
- Locks in place to prevent theft.
- Anti-rotating locking feature.
- For Ø 32 - Ø 34mm bars.

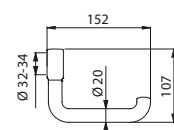

510081

Toilet roll holder for grab bars HR Nylon bright grey anthracite	510081
---	---------------

Bright ECO straight grab bar

Tube Ø 25mm



- Bright polished 304 stainless steel.
- Visible fixings, secured to wall by a 3-hole plate.

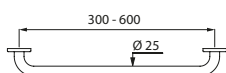

530/531/532/536

ECO straight grab bar Ø 25mm	
Bright polished 304 stainless steel - 300mm	530
Bright polished 304 stainless steel - 400mm	531
Bright polished 304 stainless steel - 500mm	532
Bright polished 304 stainless steel - 600mm	536

Bright ECO angled grab bar 135°

Tube Ø 25mm



- Bright polished 304 stainless steel.
- Visible fixings, secured to wall by a 3-hole plate.
- Dimensions: 220 × 220mm.

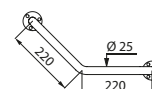

550

ECO angled grab bar 135° Ø 25mm Bright polished 304 stainless steel	550
--	------------

White powder-coated ECO straight grab bar

Tube Ø 25mm



- White powder-coated stainless steel.
- Visible fixings, secured to wall by a 3-hole plate.
- Dimensions: 300mm.

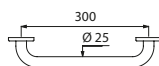

1530

ECO straight grab bar Ø 25mm White powder-coated stainless steel - 300mm	1530
---	-------------

White powder-coated ECO angled grab bar 135°

Tube Ø 25mm



- White powder-coated stainless steel.
- Visible fixings, secured to wall by a 3-hole plate.
- Dimensions: 220 × 220mm.

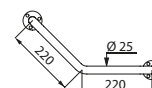

1550

ECO angled grab bar 135° Ø 25mm White powder-coated stainless steel	1550
--	-------------



DOC M PRODUCTS AND PACKS

DOC M
PACKS
162

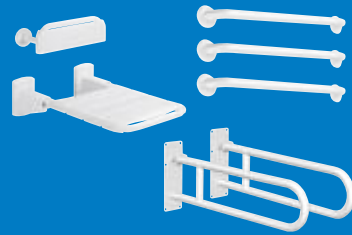
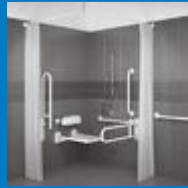

DOC M
PRODUCTS
166



DOC M
SPACE GUIDES
168

Recessed shower pack



Please note that the images are for illustration purposes only.

19 items:

- 2 Drop-down support rails, length 760mm.
- 3 Grab bars, length 600mm.
- 2 Grab bars, length 450mm.
- 1 Lift-up shower seat.
- 1 Backrest, depth 125mm.
- 1 Shower curtain rail, 1,200 × 1,200mm.
- 2 Shower curtains, white PVC.
- 1 Stainless steel coat hook.
- 1 SECURITHERM single lever sequential thermostatic recessed shower mixer.
- 1 Chrome-plated TONIC JET shower head, tamperproof and scale-resistant, with automatic flow rate regulator at 6 lpm.
- 1 Recessed diverter valve.
- 1 Multi-mode shower kit, 1.5m hose.
- 1 Shower hose retaining collar: retains shower hose correctly.
- 1 Wall outlet.

WRAS approved product no.1512029 (renewal applied for).

BuildCert certificate TMV3: BC1824/1216 (renewal applied for).

CE marked.

DOC M compliant.

DOC M Recessed shower pack	
White powder-coated	DOCMREC1
Blue powder-coated	DOCMREC2

Exposed shower pack



Please note that the images are for illustration purposes only.

19 items:

- 2 Drop-down support rails, length 760mm.
- 3 Grab bars, length 600mm.
- 2 Grab bars, length 450mm.
- 1 Lift-up shower seat.
- 1 Backrest, depth 125mm.
- 1 Shower curtain rail, 1,200 × 1,200mm.
- 2 Shower curtains, white PVC.
- 1 Stainless steel coat hook.
- 1 SECURITHERM single lever sequential thermostatic exposed shower mixer.
- 1 Chrome-plated TONIC JET shower head, tamperproof and scale-resistant, with automatic flow rate regulator at 6 lpm.
- 1 Exposed diverter valve.
- 1 Multi-mode shower kit, 1.5m hose.
- 1 Shower hose retaining collar: retains shower hose correctly.
- 1 Riser pipe, 1m.

WRAS approved product no.1410025 (renewal applied for).
BuildCert certificate TMV3: BC1363/0514 (renewal applied for).
 CE marked.
 DOC M compliant.

DOC M Exposed shower pack	
White powder-coated	DOCMEXP1
Blue powder-coated	DOCMEXP2

Basic shower or changing room pack

Shower seat without leg



doc M compliant CE

- 1 lift-up shower seat, 650 × 420mm.
- 1 backrest, depth 125mm.
- 2 drop-down support rails, length 760mm.
- 3 grab bars, length 600mm.
- Grab bars and shower seat: aluminium.
- Drop-down support rails: stainless steel.
- Tested to over 200kg. Maximum recommended user weight: 135kg.
- CE marked.
- DOC M compliant.

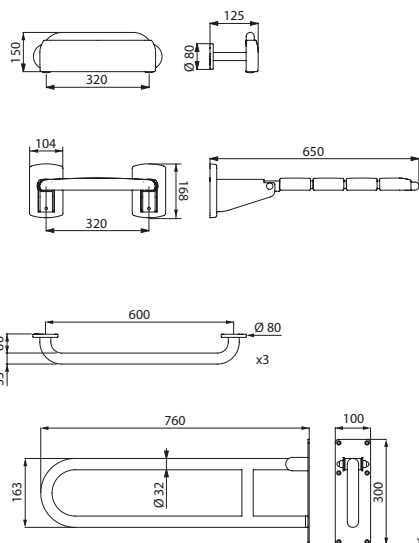

Basic shower or changing room pack

Shower seat with leg



doc M compliant CE

- 1 lift-up shower seat with leg, 650 × 420mm. Seat height: 480mm.
- 1 backrest, depth 125mm.
- 2 drop-down support rails, length 760mm.
- 3 grab bars, length 600mm.
- Grab bars and shower seat: aluminium.
- Drop-down support rails: stainless steel.
- Tested to over 200kg. Maximum recommended user weight: 135kg.
- CE marked.
- DOC M compliant.

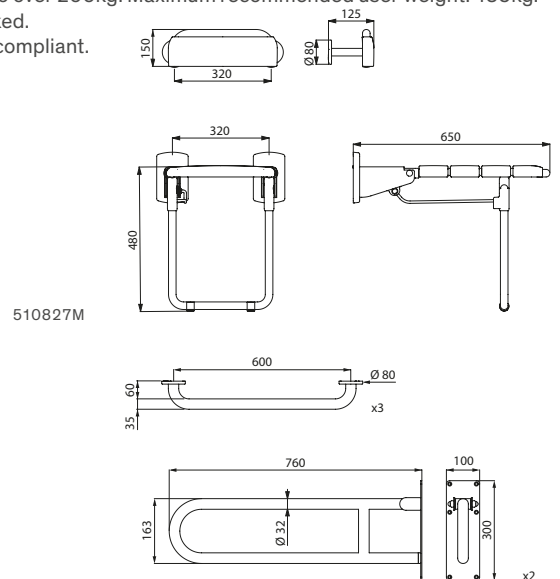

DOC M Basic shower or changing room pack - Shower seat without leg	
White powder-coated	510821MW
Blue powder-coated	510821MB

DOC M Basic shower or changing room pack - Shower seat with leg	
White powder-coated	510827MW
Blue powder-coated	510827MB

Basic WC pack with backrest



- 1 backrest, depth 125mm (ref. 510809M) or depth 250mm (ref. 510819M).
- 1 drop-down support rail, length 760mm.
- 4 grab bars, length 600mm.
- Grab bars and backrest: aluminium.
- Drop-down support rail: stainless steel.
- Tested to over 200kg.
- Maximum recommended user weight: 135kg.
- CE marked.
- DOC M compliant.

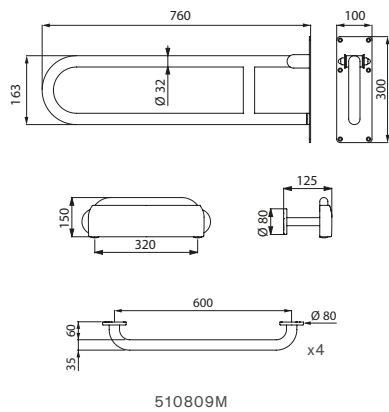

Basic WC pack



- 1 drop-down support rail, length 760mm.
- 4 grab bars, length 600mm.
- Grab bars: aluminium.
- Drop-down support rail: stainless steel.
- Tested to over 200kg.
- Maximum recommended user weight: 135kg.
- CE marked.
- DOC M compliant.

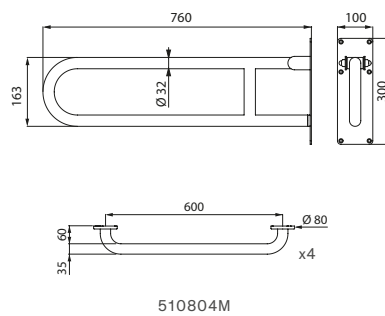

Ambulant WC Basic pack



- 3 grab bars, length 600mm.
- Aluminium tube Ø 35mm.
- Concealed fixings, secured to wall by a 3-hole plate.
- Tested to over 200kg.
- Maximum recommended user weight: 135kg.
- CE marked.
- DOC M compliant.

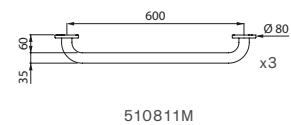

DOC M Basic WC pack with backrest	
White powder-coated	
Depth 125mm	510809MW
Depth 250mm	510819MW
DOC M Basic WC pack with backrest	
Blue powder-coated	
Depth 125mm	510809MB
Depth 250mm	510819MB

DOC M Basic WC pack	
White powder-coated	510804MW
Blue powder-coated	510804MB

DOC M ambulant WC Basic pack	
White powder-coated aluminium	510811MW
Blue powder-coated aluminium	510811MB

Aluminium grab bar



- **Aluminium** tube \varnothing 35mm.
- Concealed fixings, secured to wall by a 3-hole plate.
- Dimensions: 300, 450 or 600mm centre-to-centre.
- Tested to over 200kg. Maximum recommended user weight: 135kg.
- CE marked. DOC M compliant.

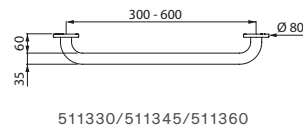

511330/511345/511360

DOC M grab bar – White powder-coated aluminium	
300mm	511330W
450mm	511345W
600mm	511360W
DOC M grab bar – Blue powder-coated aluminium	
300mm	511330B
450mm	511345B
600mm	511360B

Nylon grab bar



- **High-strength polyamide (Nylon)**, \varnothing 32mm.
- Concealed fixings, secured to wall by a 6-hole plate.
- Dimensions: 300 or 600mm centre-to-centre.
- Tested to over 200kg. Maximum recommended user weight: 135kg.
- CE marked.
- DOC M compliant.

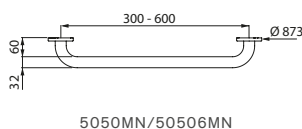

5050MN/50506MN

DOC M grab bar - HR Nylon bright white	
300mm	5050MN
600mm	50506MN

Stainless steel drop-down support rail



- **Stainless steel** tube \varnothing 32mm.
- Visible fixings, secured to wall by a 6-hole stainless steel plate.
- Length 760mm.
- Tested to over 200kg. Maximum recommended user weight: 135kg.
- CE marked.
- DOC M compliant.

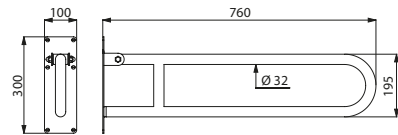

511516

DOC M drop-down support rail	
White powder-coated stainless steel	511516W
Blue powder-coated stainless steel	511516B

Nylon drop-down support rail



- **High-strength polyamide (Nylon)**, \varnothing 32mm.
- Concealed fixings, secured to wall by a 304 stainless steel cover plate.
- Length 850mm.
- Tested to over 200kg. Maximum recommended user weight: 135kg.
- CE marked. DOC M compliant.

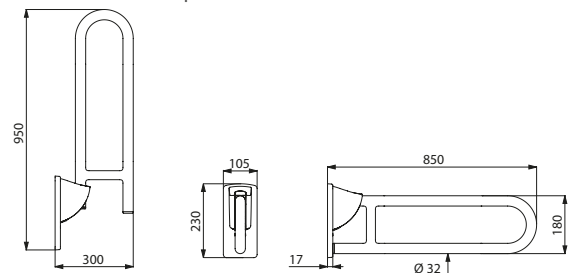

5164N

DOC M drop-down support rail - HR Nylon bright white	
	5164N

Shower seat



- Large plastic slats are easy to maintain.
- Structure made from aluminium tube.
- Concealed fixings.
- Dimensions: 650 × 420mm.
- Tested to over 200kg. Maximum recommended user weight: 135kg.
- CE marked.
- DOC M compliant.

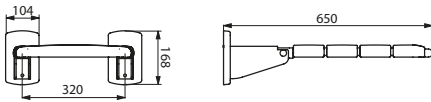

511423

DOC M shower seat	
White powder-coated aluminium	511423W
Blue powder-coated aluminium	511423B

Shower seat with leg



- Large plastic slats are easy to maintain.
- Structure made from aluminium tube.
- Reinforced by a folding, articulated leg.
- Concealed fixings.
- Dimensions: 650 × 420mm.
- Seat height: 480mm.
- Tested to over 200kg. Maximum recommended user weight: 135kg.
- CE marked.
- DOC M compliant.

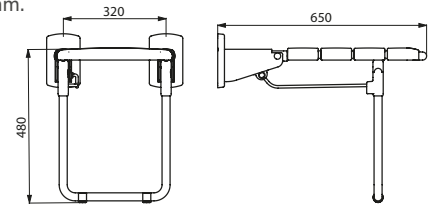

511431

DOC M shower seat with leg	
White powder-coated aluminium	511431W
Blue powder-coated aluminium	511431B

Backrest



- Plastic backrest, easy to maintain.
- Structure made from aluminium tube.
- Concealed fixings, secured to wall by a 3-hole plate.
- Dimensions: 320 × 150mm.
- CE marked.
- DOC M compliant.



511629

511628

DOC M backrest – White powder-coated aluminium	
Depth 125mm	511629W
Depth 250mm	511628W
DOC M backrest – Blue powder-coated aluminium	
Depth 125mm	511629B
Depth 250mm	511628B

DISABILITY DISCRIMINATION ACT (DDA) AND DOC M: REMOVING PHYSICAL BARRIERS

From October 2004, the revised DDA requires that "All suppliers of services, goods and facilities for the general public must remove all physical barriers, where deemed reasonable". The DOC M (Part M of the Building Regulations 2010) recommends and imposes a variety of alternative layouts and product combinations in response to these obligations.

DELABIE has therefore developed a product offering, including special packs, which conform to the recommendations of DOC M. The objective is to allow everyone - disabled people, older people or those with reduced mobility - easy access and to maintain maximum independence in their day-to-day life.

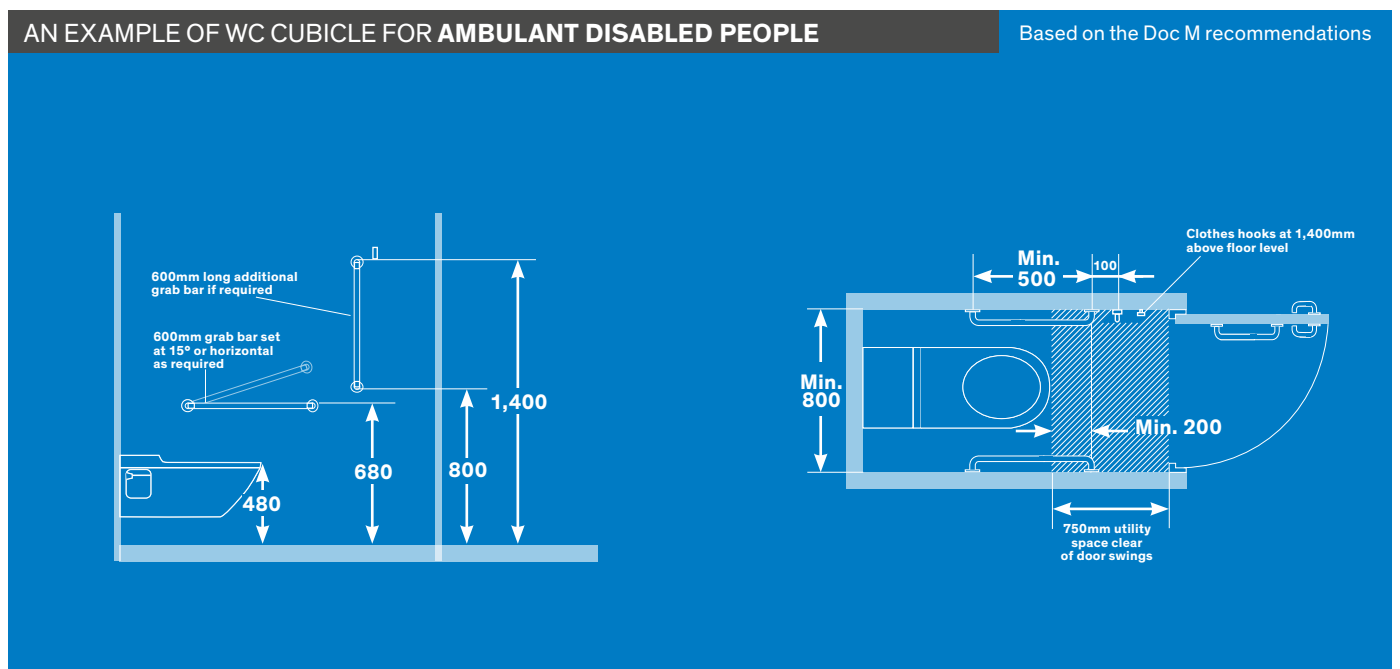
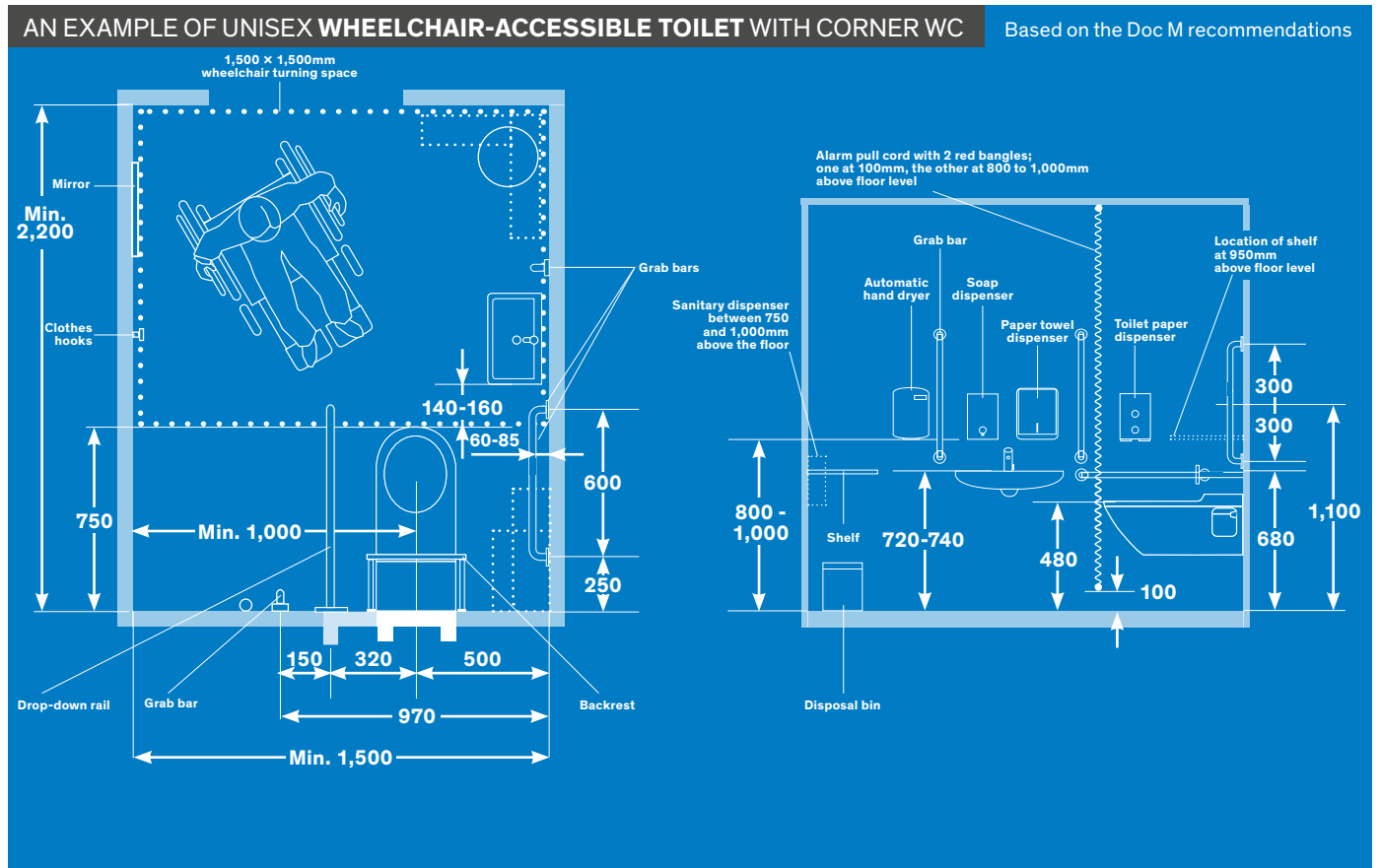

AN EXAMPLE OF A SELF-CONTAINED **SHOWER ROOM** FOR INDIVIDUAL USE

Based on the Doc M recommendations

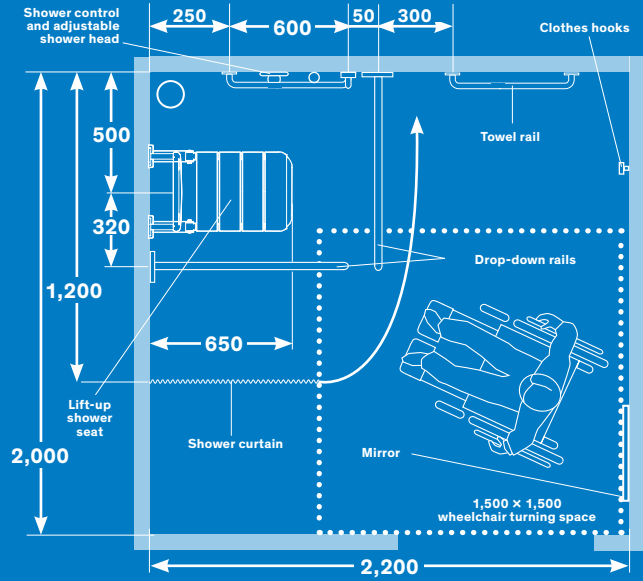
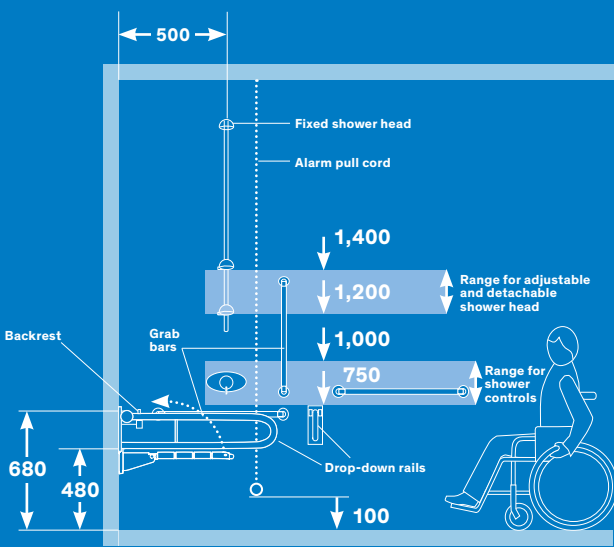

AN EXAMPLE OF A SELF-CONTAINED **CHANGING ROOM** FOR INDIVIDUAL USE

Based on the Doc M recommendations

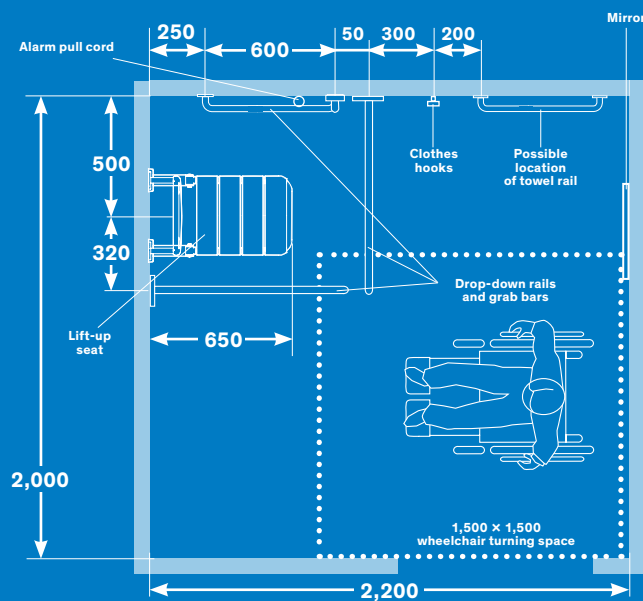
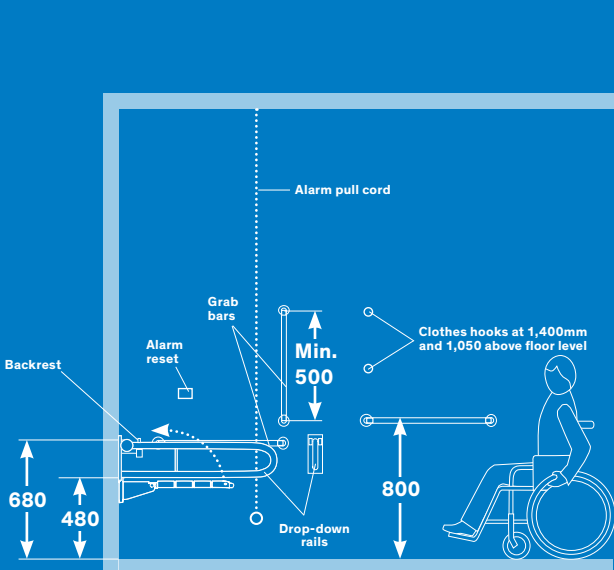



ACCESSIBILITY

Access is a right for people with reduced mobility. Architectural and technical provision must be made to allow everyone, disabled people, the elderly and those with reduced mobility, to **maintain maximum independence** in their day-to-day life.

In particular, they must have **easy access to all public places** such as civic buildings, cultural centres, hospitals, shops, buildings with communal living, individual housing...

THE DELABIE SOLUTION

The DELABIE Group through its Accessibility and Independence – Hygienic Accessories range delivers **a complete range** of grab bars and rails as well as accessories (shower seats, soap dispensers, coat hooks, hand dryers, etc.). Hence **facilities can be adapted** to meet the specific needs of all users, regardless of their age or level of independence.

This guide provides recommendations and advice for the correct installation of our products.

However, the information is provided for guidance only. **The information and installation advice must be adapted to the appropriate regulations where they exist (e.g. installation height, length, number of products and accessible facilities, layout, etc.). These may vary considerably from country to country.**

In order to meet these requirements, **sanitary installations** such as shower cubicles, changing rooms, wash basins and toilets should be adapted to ensure that they are suitable for disabled people.

For DOC M recommendations see pages 161-169.

WCs

Every building providing public toilets facilities should incorporate a toilet that is accessible **by wheelchair users** and **an accessible washbasin** on every floor that has public access.

Disabled toilets should be installed near to non-disabled toilets so that they are grouped together.

If there are separate toilets for each sex, a disabled toilet should be available for each sex. Washbasins, or at least one washbasin per group of washbasins, should be accessible by disabled people, as well as the various fittings, especially **mirrors, soap dispensers and hand dryers.**

Buildings with accommodation

All buildings that provide accommodation for the public must also provide rooms that are suitable for disabled use and that can be occupied by a person in a wheelchair.

Ratio of adapted rooms in relation to the total number of bedrooms in the building	
Up to 20 rooms	1 room
Up to 50 rooms	2 rooms
More than 50 rooms	1 additional room for every 50 rooms

Buildings accommodating older people or people with a motor disability

All bedrooms or accommodation, bathrooms, showers and toilets must be suitable for disabled people.

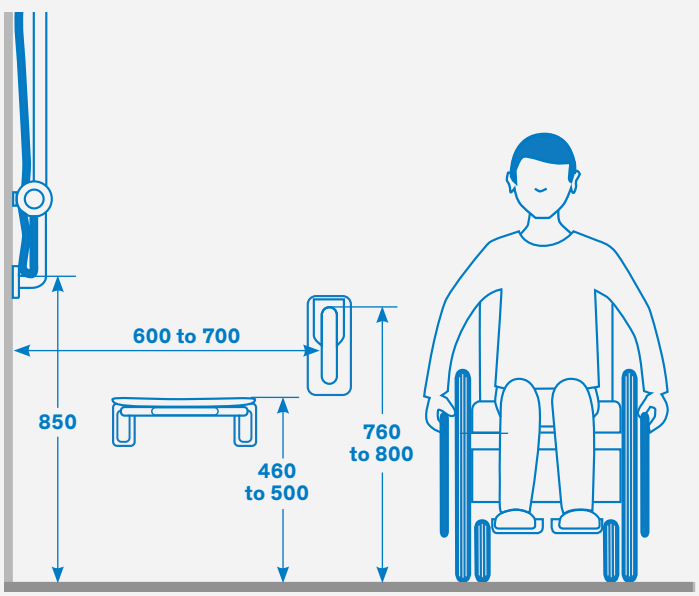
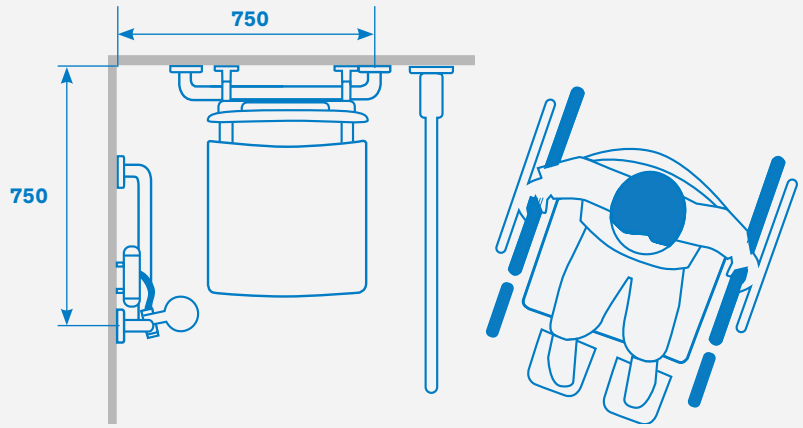
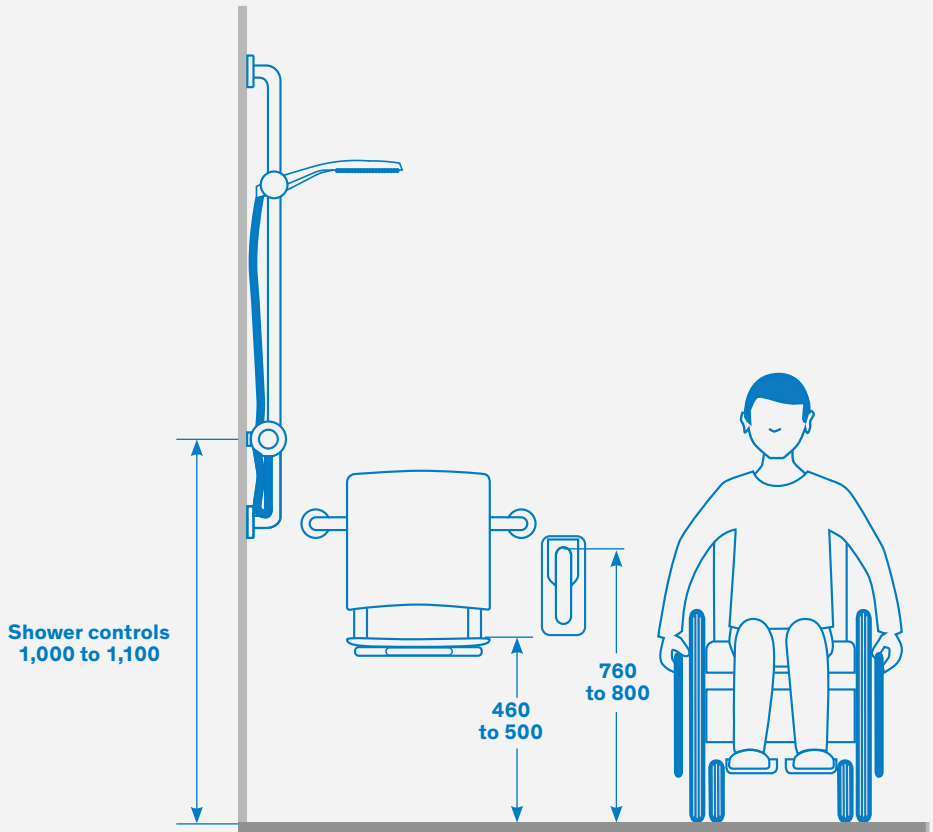

SHOWERS

In buildings that provide showers or changing rooms (swimming pools, hotels, hospitals, retirement homes, etc.) showers should incorporate in principle:

- Equipment enabling people to sit down and access to a support when seated or standing: **a removable or lift-up shower seat, support bars with a vertical bar and drop-down support rails.**
- **A free space - known as a utility space (0.80m x 1.30m)** - next to the equipment, providing easy access for wheelchair users.
- Equipment accessible from the seated position: **coat hooks, adapted taps, hair dryers, mirrors, sliding shower head holders, etc.**
- A floor trap.

We recommend installing a thermostatic mixer - or a tap with a maximum temperature limiter - with a cool-touch body and ergonomic long lever (**see our catalogue - Water Controls for Hospitals**).

CHANGING ROOMS

Changing rooms should similarly provide a seat with suitable support bars as well as a utility space 1,500mm in front of the lockers.

The various accessories should be equally accessible e.g. coat hooks and mirrors.

For DOC M recommendations see pages 161-169.

Examples of suitable products



Removable shower seat to hang on grab bars
Ref. 510300N



Removable lift-up Be-Line® shower seat
Ref. 511920C



Drop-down support rail
Ref. 5160N



Be-Line® two-wall grab bar with vertical bar
Ref. 511949C

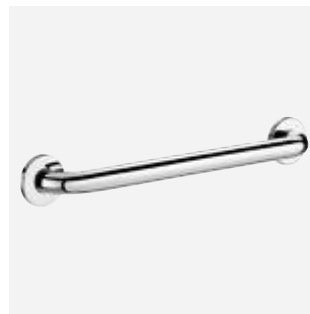

Straight grab bars 300 - 900mm
Refs. 5050, 50504, 50505...



Sliding shower head holder and sliding soap dish
Refs. 4110P and 510120



Thermostatic mixer
Ref. H9741

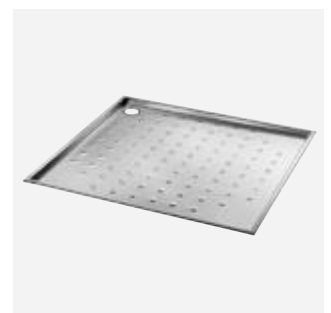

Slimline shower tray
Ref. 150500

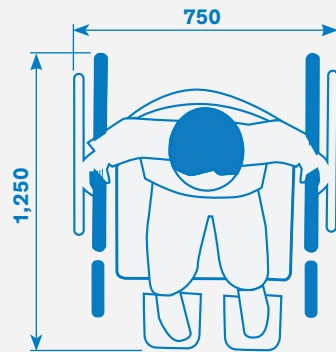
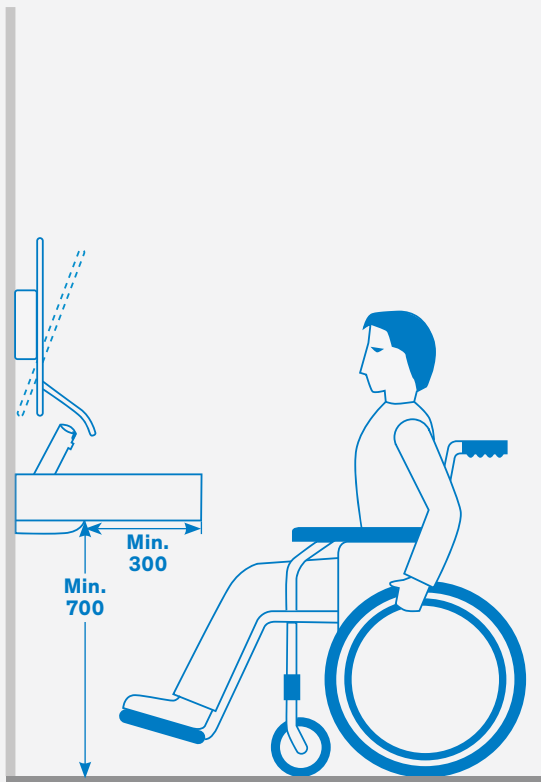
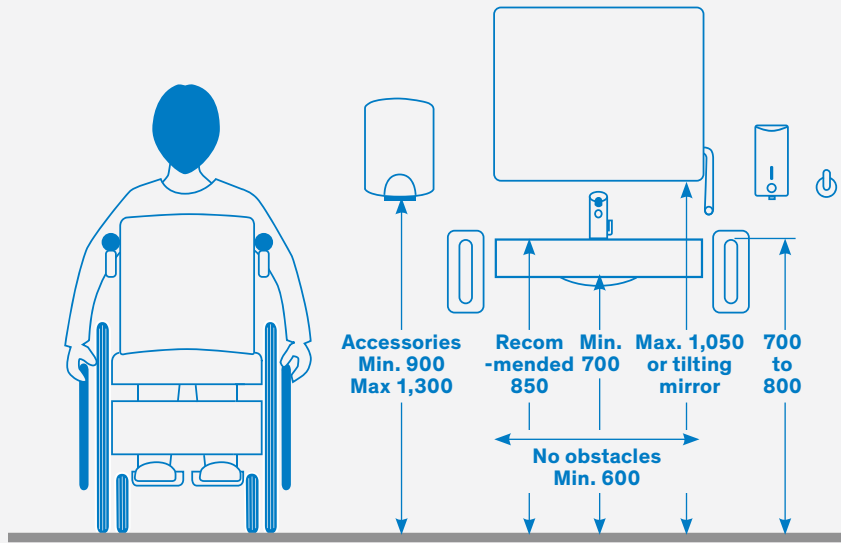

Standard dimensions
 for a wheelchair

WASHBASINS

Disabled WCs should incorporate **specific washbasins**.

The top of the washbasin should be installed at the recommended height of 850mm and there should be a free area at least 300mm deep, at a height of 700mm, underneath the washbasin to allow easy access for wheelchair users.

Other equipment such as **hand dryers, soap dispensers and taps** should be accessible for users in a seated position and placed at a height between 900 and 1,300mm.

A mirror should also be installed. If the mirror does not tilt, the lower edge should be fixed at a maximum height of 1,050mm. **Grab bars** or a **washbasin support frame** may be added.

We recommend installing an electronic or soft-touch time flow tap; or a tap with an ergonomic lever, with a maximum temperature limiter (see our catalogues **Commercial Water Controls, Water Controls for Hospitals and Stainless Steel Sanitary Ware**).

For DOC M recommendations see pages 161-169.

Examples of suitable products



Wall support rail
Ref. 510161P



Tilting mirror with long, ergonomic lever
Ref. 510201N



Electronic soap dispenser
Ref. 512066P

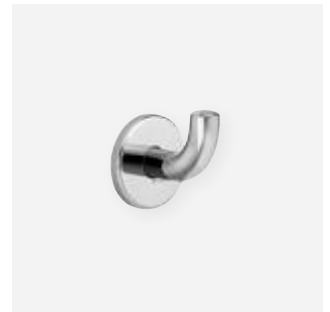

Coat hook
Ref. 4043P



HIGHFLOW air pulse hand dryer
Ref. 510622



MINERALCAST PMR washbasin
Ref. 132306

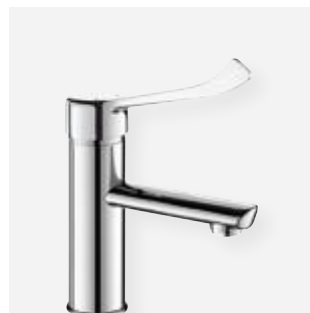

Long lever mixer
Ref. 2721L

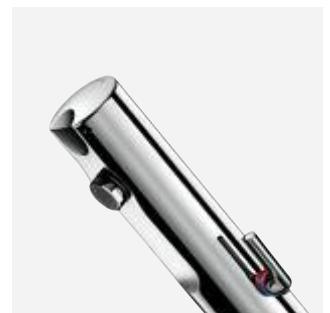

Electronic mixer
Ref. 490006

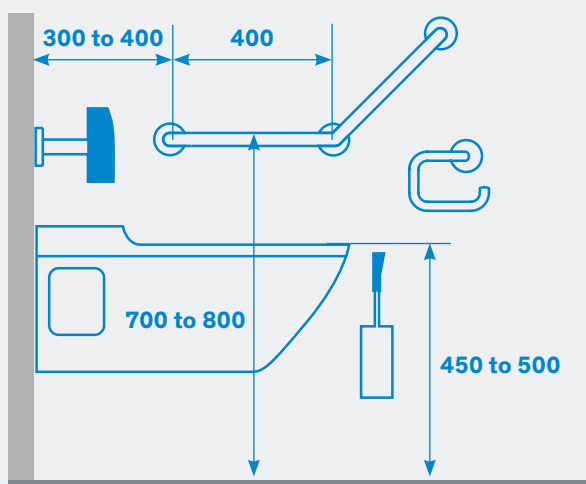
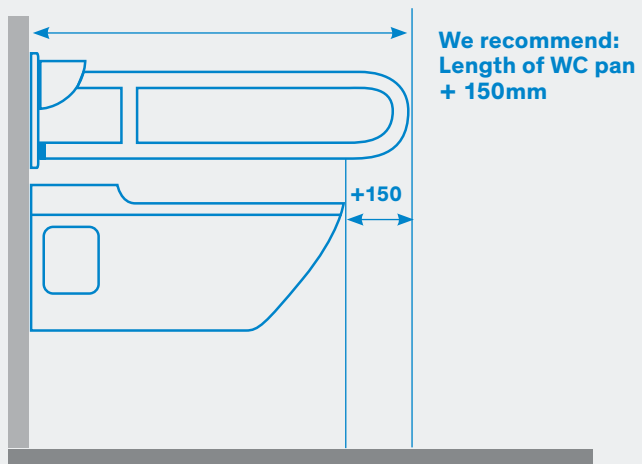
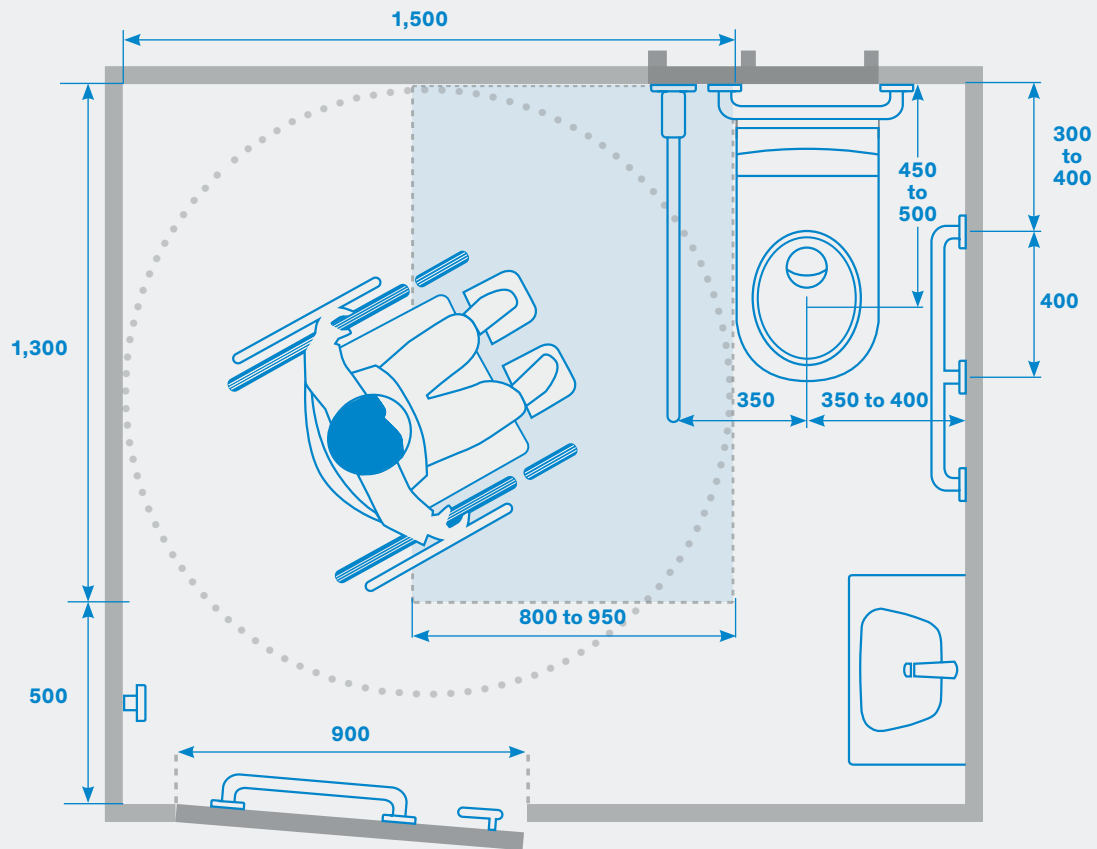

WCs

In toilets, a utility space for turning and manoeuvring should be envisaged during construction.

The toilet seat should be installed between 450 and 500mm from the floor and **at least one support bar**, to allow wheelchair users to transfer to the toilet seat, should be installed at a height between 700 and 800mm. The support bars and their fixings should be able to withstand the full weight of an adult.

A drop-down support rail will facilitate side access. We recommend that the length of the support bar should equal that of the WC pan plus approximately 150mm. If the toilet does not have an exposed cistern, a backrest should be included to avoid any risk of the user falling backwards.

A rectangular space to manoeuvre, at least 800 × 1,300mm should be provided next to the WC pan and a **turning space of 1,500mm** should also be provided to allow a wheelchair to turn through 180 degrees.

We recommend mounting a **400mm grab bar** on the back of the door to help with closing/opening.

An electronic flush is ideal for disabled toilets.

A washbasin equipped with an electronic or time-flow tap/mixer valve with soft-touch operation, or ergonomic control lever, and with a temperature limiter must be installed (see our catalogues **Commercial Water Controls, Water Controls for Hospitals and Stainless Steel Sanitary Ware**).

For DOC M recommendations see pages 161-169.

Examples of suitable products



Drop-down support rail
Ref. 510164P



Grab bar 135°
400 × 400mm
Ref. 5082P



Be-Line® straight grab bars
300 - 900mm
Ref. 511903, 511904...

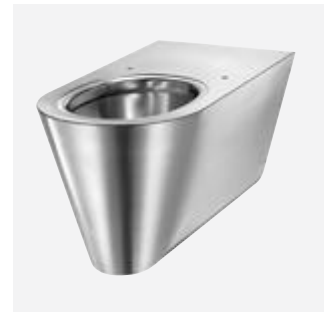

WC with 700mm pan
Ref. 110710



Frame system dual control
electronic WC
Ref. 564065 + 464006



TEMPOMATIC WC
cross wall flush
Ref. 463150



Ergonomic toilet brush set
Ref. 510051P



PMR XS washbasin
Ref. 120400

REF.	DESCRIPTION	P.	REF.	DESCRIPTION	P.
101P	Hat & coat hook polished stainless steel	35	35050W	Basic grab bar Ø32 L300 white epoxy	154
110710	700 S wall mtd WC horizontal inlet 304 stainless steel satin (ex-0112080001)	116	35081W	*Grab rail 135° Ø32 400×400 white (while stock then 35082W)	-
110790	MONOBLOCO 700 PMR WC 304 stainless steel satin with cistern	116	35082S	Basic grab bar 135° Ø32 400×400 3 fix points st steel satin	157
120270	TRAPEZ basin no tap hole 304 satin st. steel w/o overflow (ex-3411270015)	117	35082W	Basic grab bar 135° Ø32 400×400 3 fixing points white epoxy	154
120400	PMR XS basin vert waste no tap hole 304 satin stainless steel (ex-3411400015)	117	35164S	Basic drop-down rail Ø32 L850 stainless steel satin finish	157
121270	TRAPEZ basin Ø35 ctr tap hole 304 satin st. steel w/o overflow (ex-3411270008)	117	35440W	Basic T-shaped shower handrail Ø32 1150×500 white epoxy	154
1301W	Robe hook x 1 hook stainless steel and metal white epoxy	37	35481W	Shower bar + upright Basic Ø32 white powder coated	155
1302W	Robe hook x 2 hooks stainless steel and metal white epoxy	37	355	Straight curtain rail polished st steel Ø16 - 1m cut-to-size	47
1303W	Robe hook x 3 hooks stainless steel and metal white epoxy	37	356	Straight curtain rail polished st steel Ø16 - 2m cut-to-size	47
132306	MINERALCAST PMR wall mounted basin L.785 Ø35 centre hole	148	3561	Toilet seat protector dispenser polished stainless steel	13
1358	ECO telescopic curtain rail Ø20 - 0.8-2.10m polished alu	47	3562	250 × Toilet seat protectors	13
1367	Angled curtain rail Ø20 - 0.9×0.9m polished stainless steel	47	3565	Toilet roll holder white epoxy 304 stainless steel	7
138	Robe hook chrome plated brass	35	3569	Wall mounted soap basket angled model polished st steel	35
1381	Shower curtain 0.9×2m white PVC	49	358	ECO telescopic curtain rail Ø20 - 0.76-1.26m polished alu	47
1382	Shower curtain 1.2×2m white PVC	49	359	Extending curtain rail Ø20 polished stainless steel	47
1386	Shower curtain 1.8×2m white PVC	49	360	Angled curtain rail Ø16 - 0.7×0.7m polished stainless steel	47
1449	Round pedal bin 3L white epoxy	18	361	Angled curtain rail Ø16 - 0.8×0.8m polished stainless steel	47
150500	PMR 800×800 shower tray depth 30mm 304 stainless steel satin (ex-0513050000)	117	362	Adj angled curtain rail 0.7-0.9m polished stainless steel	47
150600	PMR 900×900 shower tray depth 30mm 304 stainless steel satin (ex-0513060000)	117	374001	Hypereco liquid soap dispenser 0.9L white ABS	51
1530	ECO grab bar Ø25 L300 white epoxy stainless steel	158	379	Non slip shower mat white rubber	49
1550	ECO grab rail 135° Ø25 220×220 white epoxy stainless steel	158	381	Shower curtain 0.9×1.8m white PVC	49
1660	Toilet paper dispenser 2 rolls polished stainless steel	7	382	Shower curtain 1.2×1.8m white PVC	49
1660S	Toilet paper dispenser 2 rolls stainless steel satin finish	7	387	Shower curtain 1.8×1.8m white PVC	49
1661	Toilet paper dispenser 2 rolls white epoxy	7	390	6 × Shower curtain rings chrome plated brass	49
2359	Straight curtain rail polished st steel Ø20 - 1m cut-to-size	47	390BIS	6 × Shower curtain rings plastic	49
2390	Sleeve connector for 2 tubes Ø20	46	393	Removable slatted shower seat - large model	84
2392	2 × Fixing plates for tube Ø20	46	395	Removable slatted shower seat	84
2393	Angled connector for tube Ø20	46	4042P	Robe hooks x 2 hooks polished stainless steel	36
2396	Polished stainless steel tube Ø20 L600	46	4042S	Robe hooks x 2 hooks polished satin stainless steel	36
2397	Polished stainless steel tube Ø20 L700	46	4042W	Robe hooks x 2 hooks white epoxy stainless steel	36
2398	Polished stainless steel tube Ø20 L800	46	4043EW	Coat hook Ø62 × 65 white epoxy stainless steel	36
2399	Polished stainless steel tube Ø20 L900	46	4043N	Coat hook Ø62×65 Nylon	36
2400	Polished stainless steel tube Ø20 L1000	46	4043P	Coat hook Ø62×65 polished stainless steel	36
2561D	Hygienic bag dispenser & container stainless steel	14	4043S	Coat hook Ø62×65 stainless steel satin finish	36
2900	Toilet paper dispenser 200m white lacquered steel	9	4047EW	Coat hook Ø62×100 white epoxy stainless steel	36
2901	Toilet paper dispenser 200m polished 304 stainless steel	9	4047P	Coat hook Ø62×100 polished stainless steel	36
2902	Toilet paper dispenser 200m 304 stainless steel satin finish	9	4048EW	WC brush set wall mounted without lid white epoxy st steel	10
2909	Hypereco toilet paper dispenser 400m white ABS	51	4048P	WC brush set wall mounted without lid polished st steel	10
2910	Toilet paper dispenser 400m white lacquered steel	9	4048S	WC brush set wall mounted without lid stainless steel satin	10
2911	Toilet paper dispenser 400m polished 304 stainless steel	9	4049EW	WC brush set floor standing without lid white epoxy st steel	10
2912	Toilet paper dispenser 400m 304 stainless steel satin finish	9	4049P	WC brush set floor standing without lid polished st steel	10
301	Robe hook x 1 hook polished stainless steel and chrome	37	4049S	WC brush set floor standing without lid st steel satin	10
302	Robe hook x 2 hooks polished stainless steel and chrome	37	4050EW	WC brush set floor standing with lid white epoxy st steel	11
303D	Robe hook x 3 hooks polished stainless steel and chrome	37	4050P	WC brush set floor standing with lid polished st steel	11
3361	Hypereco WC brush set wall or floor mounted	50	4050S	WC brush set floor standing with lid st steel satin finish	11
3362	Toilet brush Nylon (for brush set 3361)	50	4051EW	WC brush set wall mounted with lid white epoxy st steel	11
3364	Eco ceiling support L800 for rail Ø16 st steel + brass	48	4051N	WC brush wall mounted with ergonomic handle white Nylon	13
3365	Eco ceiling support L800 for rail Ø20 st steel + brass	48	4051P	WC brush set wall mounted with lid polished stainless steel	11
3372	Ceiling support L1000 for rail Ø16 polished stainless steel	48	4051S	WC brush set wall mounted with lid stainless steel satin	11
3411400015	New coding:120400	-	4070N	Spare toilet roll holder white Nylon	7
3450	Rectangular bathroom mirror 420×600 6mm thick	42	4070P	Spare toilet roll holder polished stainless steel	7
3451	Rectangular bathroom mirror 360×480 6mm thick	42	4070S	Spare toilet roll holder polished satin stainless steel	7
3452	Unbreakable bathroom mirror 10×385×485 mirror pol st steel	43	4081EW	U-shaped toilet roll holder white epoxy stainless steel	6
3453	Unbreakable bathroom mirror 1×400×600 polished st steel	43	4081N	U-shaped toilet roll holder white Nylon	6
3454	Rectangular bathroom mirror 500×750 6mm thick	42	4081P	U-shaped toilet roll holder polished stainless steel	6
3458	Unbreakable bathroom mirror 10×485×585 mirror pol st steel	43	4081S	U-shaped toilet roll holder stainless steel satin finish	6
3459	Unbreakable bathroom mirror 10×595×980 mirror pol st steel	43	4110P	Shower head holder chrome plated metal for bar Ø25 & Ø32	111
350504S	Basic grab bar Ø32 L400 stainless steel satin finish	157	4201EW	*Tilt mirror+hdl 420×600 white ss (while stock then 510201N)	-
350504W	Basic grab bar Ø32 L400 white epoxy	154	4201P	*Adj mirror + handle 420×600 bright (while stk then 510202P)	-
350505S	Basic grab bar Ø32 L500 stainless steel satin finish	157	4201S	*Adj mirror + handle 420×600 satin (while stk then 510202S)	-
350505W	Basic grab bar Ø32 L500 white epoxy	154	423	Lift-up shower seat with slats	84
350506S	Basic grab bar Ø32 L600 stainless steel satin finish	157	431	Lift-up shower seat with slats with leg	84
350506W	Basic grab bar Ø32 L600 white epoxy	154	432	Replaced by 435	-
35050S	Basic grab bar Ø32 L300 stainless steel satin finish	157	4337B	DOC M curtain rail 1200×1200 + arm blue epoxy stainless steel	-

References prefixed by * are available while stocks last. References are listed in ascending alphanumerical order.

REF.	DESCRIPTION	P.	REF.	DESCRIPTION	P.
4337W	DOC M curtain rail 1200x1200 + arm white epoxy st steel	-	5083N	Grab rail 135° Ø32 220x220 3 fix. points wht Nylon	126
435	Toilet booster seat with lid white plastic	112	5083P	Grab rail 135° Ø32 220x220 2 fix. points polished st steel	88
4359	Straight curtain rail polished st steel Ø20 - 2m cut-to-size	47	5083S	Grab rail 135° Ø32 220x220 2 fixing points st steel satin	88
437	Lift-up shower seat with slats - large model	84	5086E2W	*Grab rail 135° Ø25 400x400 white (while stock then 5082W)	-
4373	Ceiling support L1000 for rail Ø20 polished stainless steel	48	5086P2	Grab rail 135° Ø25 400x400 2 fix. points polished st steel	88
438	Lift-up shower seat with slats with leg - large model	84	5087P	Grab rail 135° Ø25 400x400 3 fix. points polished st steel	89
447	Non slip duck board semi-rigid white plastic	49	5087W	*Grab rail 135° Ø25 400x400 3 fix wht (while stk then 5082W)	-
448	WC brush set wall or floor mounted polished stainless steel	13	5090N	*U-shaped grab rail Ø32 white Nylon (while stock lasts)	-
448BIS	Toilet brush polished stainless steel (for brush set 448)	13	510042N	Double hook white Nylon	37
449	Round pedal bin 3L polished stainless steel	18	510043N	Single hook white Nylon	37
450P	Round pedal bin 5L polished stainless steel	18	510050P	WC brush set floor standing lid + ergo handle pol st steel	12
460	Wall mounted rectangular bin 13L polished stainless steel	18	510050S	WC brush set floor standing lid + ergo handle st steel satin	12
462	Wall mounted rectangular bin with cover 13L pol st steel	18	510050W	WC brush set floor standing lid + ergo handle wht ep st steel	12
465	Slimline wall mounted rectangular bin 4,5L polished st steel	18	510051P	WC brush set wall mounted lid + ergo handle polished st steel	12
465S	Slimline wall mounted rectangular bin 4.5L satin st. steel	18	510051S	WC brush set wall mtd lid + ergonomic handle st steel satin	12
50504E2W	*Grab bar Ø32 L400 white powder st st (while stk then 50504N)	-	510051W	WC brush set wall mtd lid + ergo handle white epoxy st steel	12
50504N	Grab bar Ø32 L400 white Nylon	128	510081	Toilet roll holder for bars Ø32-34 grey Nylon	112
50504P2	Grab bar Ø32 L400 polished stainless steel	87	510081N	Toilet roll holder for bars Ø32-34 white Nylon	143
50504S	Grab bar Ø32 L400 Stainless steel satin finish	87	510082P	Double toilet roll holder bright polished stainless steel	6
50505E2W	*Grab bar Ø32 L500 white powder st st (while stk then 50505N)	-	510082S	Double toilet roll holder polished satin stainless steel	6
50505N	Grab bar Ø32 L500 white Nylon	128	510082W	Double toilet roll holder epoxy coated stainless steel	6
50505P2	Grab bar Ø32 L500 polished stainless steel	87	510083P	Single toilet roll holder bright polished stainless steel	6
50505S	Grab bar Ø32 L500 stainless steel satin finish	87	510083S	Single toilet roll holder polished satin stainless steel	6
50506E2W	*Grab bar Ø32 L600 white powder st st (while stk then 50506N)	-	510083W	Single toilet roll holder epoxy coated stainless steel	6
50506MN	DOC M Grab bar Ø32 L600 white Nylon	166	5100DP2	Right-angled bar (right) Ø32 polished stainless steel	101
50506N	Grab bar Ø32 L600 white Nylon	128	5100DS	Right-angled bar (right) Ø32 stainless steel satin	101
50506P2	Grab bar Ø32 L600 polished stainless steel	87	5100GP2	Right-angled bar (left) Ø32 polished stainless steel	101
50506S	Grab bar Ø32 L600 stainless steel satin finish	87	5100GS	Right-angled bar (left) Ø32 stainless steel satin finish	101
50509E2W	*Grab bar Ø32 L900 white powder st st (while stk then 50509N)	-	5100N	Right-angled bar Ø32 white Nylon	133
50509N	Grab bar Ø32 L900 white Nylon	128	510104S	Anti-lig coat hook Ø90 304 st steel satin (ex-0011040000)	37
50509P2	Grab bar Ø32 L900 polished stainless steel	87	510110	Shower head holder white Nylon for bar Ø32	143
50509S	Grab bar Ø32 L900 Stainless steel satin finish	87	510110NG	Shower head holder grey Nylon for bar Ø32	111
5050E2W	*Grab bar Ø32 L300 white powder st. st. (while stk then 5050N)	-	510120	Clip-on sliding shower soap dish clear for bar Ø25&32	111
5050MN	DOC M Grab bar Ø32 L300 white Nylon	166	510120N	Clip-on sliding shower soap dish white Nylon for bar Ø25&32	143
5050N	Grab bar Ø32 L300 white Nylon	128	510125S	(ex-0011250000) Replaced by 3459	-
5050P2	Grab bar Ø32 L300 polished stainless steel	87	510150	Chrome-plated cover plate (bars 510160-510164-510162-510170)	93-95
5050S	Grab bar Ø32 L300 stainless steel satin finish	87	510150N	Cover plate white Nylon (for bars 5160N-5164N-5162N-5170N)	130
50510S	Grab bar Ø32 L.1050 Stainless steel satin	-	510151S	Female wall sticker 304 st steel satin (ex-0011410000)	38
5055P2	Grab bar Ø25 L300 polished stainless steel	86	510152S	Male wall sticker 304 stainless steel satin (ex-0011400000)	38
5056P2	Grab bar Ø25 L400 polished stainless steel	86	510153S	Disabled wall sticker 304 st steel satin (ex-0011370000)	38
5057P2	Grab bar Ø25 L500 polished stainless steel	86	510154S	WC wall sticker 304 stainless steel satin (ex-0011420000)	38
5058P2	Grab bar Ø25 L600 polished stainless steel	86	510155S	Mixed disabled sticker 304 st steel satin (ex-0011380000)	38
5059P2	Grab bar Ø25 L900 polished stainless steel	86	510156S	Wall sign, baby changing room, 304 satin stainless steel	38
5060DP2	*Floor-wall support rail (right) Ø32 bright ss (out of stock)	-	510158	White polyester weighted shower curtain 790 x 880mm + rings	49
5060DS	Discontinued	-	510159N	Lift-up splash guard curtain rail L. 900mm white Nylon	142
5060GP2	*Floor-wall support rail (left) Ø32 bright ss (out of stock)	-	510159P	Lift-up splash guard curtain rail L. 900mm polished st steel	110
5060GS	Discontinued	-	510159S	Lift-up splash guard curtain rail L. 900mm satin st steel	110
5070DP2	L-shaped handrail (right) Ø32 H750 polished stainless steel	103	510160P	Drop-down support rail Ø32 L650 polished stainless steel	93
5070DS	L-shaped handrail (right) Ø32 H750 stainless steel satin	103	510160S	Drop-down support rail Ø32 L650 stainless steel satin finish	93
5070GP2	L-shaped handrail (left) Ø32 H750 polished stainless steel	103	510161P	Wall support rail Ø32 L650 polished stainless steel	94
5070GS	L-shaped handrail (left) Ø32 H750 stainless steel satin	103	510161S	Wall support rail Ø32 L650 stainless steel satin finish	94
5070N	L-shaped handrail Ø32 H750 white Nylon	135	510162P	Drop-down rail with leg Ø32 L650 polished stainless steel	95
5071DP2	L-shaped handrail (right) Ø32 H1150 polished stainless steel	103	510162S	Drop-down rail with leg Ø32 L650 stainless steel satin	95
5071DS	L-shaped handrail (right) Ø32 H1150 stainless steel satin	103	510164P	Drop-down support rail Ø32 L850 polished stainless steel	93
5071GP2	L-shaped handrail (left) Ø32 H1150 polished stainless steel	103	510164S	Drop-down support rail Ø32 L850 stainless steel satin finish	93
5071GS	L-shaped handrail (left) Ø32 H1150 stainless steel satin	103	510170P	Drop-down rail with leg Ø32 L850 polished stainless steel	95
5071N	L-shaped handrail Ø32 H1245 white Nylon	135	510170S	Drop-down rail with leg Ø32 L850 stainless steel satin	95
5081E2W	Replaced by 5082W	-	510201N	Adjustable mirror 600 x 500mm with white Nylon handle	41-75
5081N	Grab rail 135° Ø32 400x400 3 fixing points white Nylon	127	510202C	Adjustable mirror 600 x 500mm with anthracite handle	41-75
5081P2	Grab rail 135° Ø32 400x400 2 fix. points polished st steel	88	510202N	Adjustable mirror 600 x 500mm with white handle	41-75
5081S	Grab rail 135° Ø32 400x400 2 fixing points st steel satin	88	510202P	Adjustable mirror 600 x 500mm with polished handle	41
5082P	Grab rail 135° Ø32 400x400 3 fix. points polished st steel	89	510202S	Adjustable mirror 600 x 500mm with polished satin handle	41
5082S	Grab rail 135° Ø32 400x400 3 fixing points st steel satin	89	510300	Removable Comfort shower seat polished stainless steel	81
5082W	Grab rail 135° Ø32 400x400 3 fix. points wht epoxy st steel	89	510300N	Removable Comfort shower seat white epoxy stainless steel	123

References prefixed by * are available while stocks last. References are listed in ascending alphanumerical order.

REF.	DESCRIPTION	P.	REF.	DESCRIPTION	P.
510300S	Removable Comfort shower seat stainless steel satin finish	81	510811MB	DOC M Basic Ambulant Disabled Pack aluminium blue	165
510400	ALU lift-up shower seat with leg	153	510811MW	DOC M Basic Ambulant Disabled Pack aluminium white	165
510410	ALU lift-up shower seat with leg - large model	152	510819MB	DOC M WC basic pack with backrest 320x250 aluminium blue	165
510418	ALU shower stool	153	510819MW	DOC M WC basic pack with backrest 320x250 aluminium white	165
510420	Lift-up Comfort shower seat polished stainless steel	82	510821MB	DOC M Shower pack with lift-up shower seat blue	164
510420N	Lift-up Comfort shower seat white epoxy stainless steel	124	510821MW	DOC M Shower pack with lift-up shower seat white	164
510420S	Lift-up Comfort shower seat stainless steel satin finish	82	510827MB	DOC M Shower pack with lift-up shower seat w. leg blue	164
510429	Comfort backrest for shower seat polished stainless steel	82-83	510827MW	DOC M Shower pack with lift-up shower seat w. leg white	164
510429N	Comfort backrest for shower seat white epoxy stainless steel	124	511330B	Grab bar Ø35 L300 blue epoxy aluminium	166
510429S	Comfort backrest for shower seat st steel satin finish	82-83	511330W	Grab bar Ø35 L300 white epoxy aluminium	166
510430	Lift-up Comfort shower seat + leg polished stainless steel	83	511345B	Grab bar Ø35 L450 blue epoxy aluminium	166
510430N	Lift-up Comfort shower seat with leg white epoxy	125	511345W	Grab bar Ø35 L450 white epoxy aluminium	166
510430S	Lift-up Comfort shower seat with leg st steel satin finish	83	511360B	Grab bar Ø35 L600 blue epoxy aluminium	166
510434	Lift-up Comfort shower seat + backrest polished st steel	82	511360W	Grab bar Ø35 L600 white epoxy aluminium	166
510434N	Lift-up Comfort shower seat + backrest white epoxy	124	511423B	Lift-up shower seat L650 blue epoxy	167
510434S	Lift-up Comfort shower seat + backrest st steel satin finish	82	511423W	Lift-up shower seat L650 white epoxy	167
510436	Lift-up Comfort shower seat + backrest + leg stainless steel	83	511431B	Lift-up shower seat with leg L650 blue epoxy	167
510436N	Lift-up Comfort shower seat with backrest + leg white epoxy	125	511431W	Lift-up shower seat with leg L650 white epoxy	167
510436S	Lift-up Comfort shower seat + backrest + leg st steel satin	83	511516B	Drop-down support rail Ø32 L760 blue epoxy	166
510461P	Wall mtd rect bin 25L polished 304 st steel (ex-0010350100)	17	511516W	Basic drop-down rail Ø32 L760 white epoxy	156
510461S	Wall mtd rect bin 25L 304 st steel satin (ex-0010350000)	17	511517W	Drop down rail with leg Basic Ø32 L.760 white powder coated	156
510463P	Wall mtd rect bin 38L polished 304 st steel (ex-0010890100)	17	511628B	Backrest 320x250 blue epoxy aluminium	167
510463S	Wall mtd rect bin 38L 304 st steel satin (ex-0010890000)	17	511628W	Backrest 320x250 white epoxy aluminium	167
510567	Toilet roll holder 304 stainless steel satin finish	7	511629B	Backrest 320x125 blue epoxy aluminium	167
510580	Liquid soap dispenser 1L polished 304 stainless steel	32	511629W	Backrest 320x125 white epoxy aluminium	167
510581	Liquid soap dispenser 1L white powder-coated 304 st. steel	32	511903C	Be-Line grab bar Ø35 L.300 anthracite aluminium	65
510582	Liquid soap dispenser 1L 304 stainless steel satin finish	32	511903W	Be-Line grab bar Ø35 L.300 white aluminium	65
510583	Liquid soap dispenser 0.5L polished 304 stainless steel	32	511904C	Be-Line grab bar Ø35 L.400 anthracite aluminium	65
510584	Liquid soap dispenser 0.5L white powder-coated 304 st.steel	32	511904W	Be-Line grab bar Ø35 L.400 white aluminium	65
510586	Liquid soap dispenser 0.5L 304 stainless steel satin finish	32	511905C	Be-Line grab bar Ø35 L.500 anthracite aluminium	65
510587	Electronic liquid soap dispenser	31	511905W	Be-Line grab bar Ø35 L.500 white aluminium	65
510601P	Folded paper towel dispenser polished stainless steel	15	511906C	Be-Line grab bar Ø35 L.600 anthracite aluminium	65
510601S	Folded paper towel dispenser stainless steel satin finish	15	511906W	Be-Line grab bar Ø35 L.600 white aluminium	65
510601W	Folded paper towel dispenser white epoxy	15	511909C	Be-Line grab bar Ø35 L.900 anthracite aluminium	65
510602P	(ex-0011120100) Replaced by 510601P	-	511909W	Be-Line grab bar Ø35 L.900 white aluminium	65
510602S	*SD paper towel dispenser 304 st steel satin (ex-0011120000)	14	511911C	Be-Line sliding shower head holder anthracite	74
510603S	*Paper towel dispenser st st satin (while stk then 510601S)	51	511911W	Be-Line sliding shower head holder white	74
510621	SPEEDJET automatic hand dryer with pulsed air grey metal	24	511912W	Be-Line white sliding soap dish for Be-Line bars	74
510622	HIGHFLOW automatic air pulse hand dryer bright st st	23	511920C	Be-Line removable lift-up shower seat anthracite alu no leg	60
510622S	HIGHFLOW automatic air pulse hand dryer satin finish st. st.	23	511920W	Be-Line removable lift-up shower seat white aluminium no leg	60
510622W	HIGHFLOW automatic air pulse hand dryer white st. st. finish	23	511921FW	Be-line shelf with fixing plate for refs 511920 /511930	60-61
510623C	SPEEDJET 2 automatic hand dryer with pulsed air, anthracite	25	511921W	Be-line shelf without fixing plate for refs 511920 /511930	60-61
510623W	SPEEDJET 2 automatic hand dryer with pulsed air, white	25	511930C	Be-Line removable lift-up sh. seat + metallic anthracite leg	61
510627P	Wall mounted soap dish 304 stainless steel, polished	34	511930W	Be-Line removable lift-up shower seat with white leg	61
510627S	Wall mounted soap dish 304 stainless steel satin finish	34	511941C	Be-Line corner grab bar Ø35 695x695 anthracite aluminium	72
510629	Comfort backrest for WC polished stainless steel structure	112	511941W	Be-Line corner grab bar Ø35 695x695 white aluminium	72
510629N	Nylon Comfort backrest for WC	145	511944C	Be-Line T-shaped grab bar Ø35 H.1130x500 anthracite alu	71
510629S	Comfort backrest for WC stainless steel satin finish	112	511944W	Be-Line T-shaped grab bar Ø35 H.1130x500 white aluminium	71
510711S	Soap dispenser 1L rec 304 st steel satin (ex-0013200000)	19	511946C	Be-Line bar + sliding holder Ø35 H.1050 anthracite alu	67
510712S	Paper towel dispenser rec 304 st steel satin (ex-0013120000)	19	511946W	Be-Line straight bar + sliding holder Ø35 H.1050 white alu	67
510713S	Bin with push flap 18L rec 304 st st satin (ex-0013320000)	19	511949C	Be-Line grab bar + shower head rail Ø35 anthracite aluminium	73
510714S	Paper towel disp + 10L bin rec combi unit (ex-0013680000)	21	511949W	Be-Line grab bar + shower head rail Ø35 white aluminium	73
510715S	Paper towel disp + 30L bin rec combi unit (ex-2015101324)	21	511950C	Be-Line anthracite cover plate (bars 511960-511964)	66
510716S	Dryer, paper towel disp + bin rec combi unit (ex-0013690000)	21	511950FC	Be-line anthracite cover plate (for bars 511960-511964)	66
510788P	Single towel rail Ø20 L600 polished stainless steel	39	511950FW	Be-line white cover plate (for bars 511960-511964)	66
510788S	Single towel rail Ø20 L600 stainless steel satin finish	39	511950W	Be-Line white cover plate (bars 511960-511964)	66
510788W	Single towel rail Ø20 L.600 white epoxy stainless steel	39	511960C	Be-line drop down rail Ø42 L.650 anthracite aluminium	66
510790P	Double towel rail Ø20 L600 polished stainless steel	39	511960W	Be-line drop down rail Ø42 L.650 white aluminium	66
510790S	Double towel rail Ø20 L600 stainless steel satin finish	39	511964C	Be-line drop down rail Ø42 L.850 anthracite aluminium	66
510790W	Double towel rail Ø20 L.600 white epoxy stainless steel	39	511964W	Be-line drop down rail Ø42 L.850 white aluminium	66
510804MB	DOC M WC basic pack aluminium blue	165	511970C	Be-Line L-shaped grab bar Ø35 H.750 anthracite aluminium	69
510804MW	DOC M WC basic pack aluminium white	165	511970W	Be-Line L-shaped grab bar Ø35 H.750 white aluminium	69
510809MB	DOC M WC basic pack with backrest 320x125 aluminium blue	165	511971C	Be-Line L-shaped grab bar Ø35 H.1130 anthracite aluminium	69
510809MW	DOC M WC basic pack with backrest 320x125 aluminium white	165	511971W	Be-Line L-shaped grab bar Ø35 H.1130 white aluminium	69

References prefixed by * are available while stocks last. References are listed in ascending alphanumerical order.

REF.	DESCRIPTION	P.	REF.	DESCRIPTION	P.
511982C	Be-Line grab bar 135° Ø35 400x400 3 fix pts anthracite alu	63	552	Wall shelf 120x450 white steel	40
511982W	Be-Line grab bar 135° Ø35 400x400 3 fix pts white aluminium	63	553	Wall shelf 120x600 polished stainless steel	40
511983C	Be-Line grab bar 135° Ø35 220x220 3 fix pts anthracite alu	62	554	Wall shelf 120x600 white steel	40
511983W	Be-Line grab bar 135° Ø35 220x220 3 fix pts white aluminium	62	566	Toilet roll holder polished 304 stainless steel	7
512051P	Elec. liquid soap or foam disp. 1L 304 chrome-plated st. steel	29	566TER	Hypereco toilet roll holder polished stainless steel	50
512066P	Electronic liquid soap dispenser 1L bright pol 304 st steel	31	569	Wall mounted rectangular soap basket polished st steel	35
512066S	Electronic liquid soap dispenser 1L pol satin 304 st steel	31	577	4 x Concealed lugs for mirror, 2 with spring pol st steel	42
512066W	Electronic liquid soap dispenser 1L white powder-ctd 304 st st	31	578	Round mirror studded peg Ø20 chrome plated brass	42
5120P2	Corner grab bar 2 walls Ø32 750x750 polished stainless steel	108	600	2 x Chrome plated supports for shelf L120	40-50
5120S	Corner grab bar 2 walls Ø32 750x750 stainless steel satin	108	600BIS	*2 x Extending supports for shelf (while stock then ref 600)	-
512111P	Elec. liquid soap or foam disp. CW. 304 chrome-plated st steel	29	610	Hypereco robe hook x 1 hook polished 304 stainless steel	50
512151P	Elec. liquid soap or foam disp. L.1200 spout chrome-plated	29	612	Hypereco robe hook x 2 hooks polished 304 stainless steel	50
5121N	Corner grab bar for shower seat Ø32 white Nylon	140	613	Hypereco robe hook x 3 hooks polished 304 stainless steel	50
512551P	Elec liquid soap or foam disp. 0.5L 304 chrome-plated st steel	29	6543	*2x Articulated fixings ss + chrome pltd brass (out of stock)	-
5160N	Drop-down support rail Ø32 L650 white Nylon	130	6555	Glass shelf 120x600 rounded edges	40-50
5160P1	Drop-down support rail Ø33.7 L650 polished stainless steel	97	6564	*Round soap dispenser 0.5L st steel (while stock then 510583)	-
5161N	Wall support rail Ø32 L650 white Nylon	129	6566	Hypereco liquid soap disp 1.2L 304 st steel satin finish	51
5162N	Drop-down rail with leg Ø32 L650 white Nylon	131	6567	Hypereco liquid soap dispenser 1.2L polished 304 st steel	51
5162P1	Drop-down rail with leg Ø33.7 L650 polished stainless steel	96	6568	Spare valve for liquid soap dispenser 6566 & 6567	51
5163P1	Hinged & drop-down support rail Ø33.7 L650 polished st steel	98	6569	Spare level control for soap dispenser 6566 & 6567	51
5164N	Drop-down support rail Ø32 L850 white Nylon	130	6580	Liquid soap dispenser 1L polished stainless steel	34
5164P1	Drop-down support rail Ø33.7 L850 polished stainless steel	97	6581	*Soap dispenser 1L white (while stock then 510581)	-
5165P1	Replaced by 510160P	-	6582	Liquid soap dispenser 1L stainless steel satin finish	34
5167E1W	Replaced by 5162N	-	6583	Liquid soap dispenser 0.5L polished stainless steel	34
5167P1	Replaced by 510162P	-	6584	*Soap dispenser 0.5L white (while stock then 510584)	-
5169P1	Column for wall or drop down rail H1000 st steel satin	99	6586	Liquid soap dispenser 0.5L stainless steel satin finish	34
5170E1W	Replaced by 5170N	-	6590	Paper towel dispenser polished w. central divider st steel	14
5170N	Drop-down rail with leg Ø32 L850 white Nylon	131	6601	Folded paper towel dispenser polished stainless steel	16
5170P1	Drop-down rail with leg Ø33.7 L850 polished stainless steel	96	6602	Folded paper towel dispenser white epoxy	16
5180E2W	Replaced by 5180P2	-	6603D	Hypereco folded paper towel dispenser white ABS	51
5180P2	Grab rail 90° Ø32 300x300 polished stainless steel	90	6606	160 x Folded paper towels	14-16
5180S	Grab rail 90° Ø32 300x300 stainless steel satin finish	90	6607D	Folded paper towel dispenser stainless steel satin finish	16
5181DP2	Grab rail 45° (right) Ø32 480x320 polished stainless steel	91	6611	Wall mounted paper towel bin polished stainless steel	16
5181DS	Grab rail 45° (right) Ø32 480x320 st steel satin finish	91	6612	Wall mounted paper towel bin white epoxy	16
5181GP2	Grab rail 45° (left) Ø32 480x320 polished stainless steel	91	6613D	Automatic hand dryer with adj. nozzle 360° pol 304 st steel	26
5181GS	Grab rail 45° (left) Ø32 480x320 st steel satin finish	91	6614	Auto. hand dryer with adj. nozzle 360° 304 st steel satin	26
530	ECO grab bar Ø25 L300 polished stainless steel	158	6615	Automatic hand dryer with adj. nozzle 360° white steel	26
531	ECO grab bar Ø25 L400 polished stainless steel	158	6617	Wall mounted paper towel bin stainless steel satin finish	16
532	ECO grab bar Ø25 L500 polished stainless steel	158	6621	Automatic hand dryer white ABS	27
536	ECO grab bar Ø25 L600 polished stainless steel	158	6623	*Hand dryer white ABS + grey polycarb (while stock then 6621)	-
5440N	T-shaped shower handrail Ø32 1150x500 white Nylon	136	6624	Wall mounted hairdryer with razor plug white ABS	27
5440P2	T-shaped shower handrail Ø32 1150x500 polished st steel	104	6631	Automatic hand dryer polished 304 stainless steel	27
5440S	T-shaped shower handrail Ø32 1150x500 stainless steel satin	104	6712	Hypereco liquid soap dispenser elbow control 0.9L white ABS	51
5441N	Sliding T-shaped grab bar Ø32 1150x500 white Nylon	137	6784	Single towel rail Ø14 L480 polished stainless steel	40
5441P	Sliding T-shaped grab bar Ø32 1160x500 bright polished st.st.	105	6786D	Double towel rail Ø14 L480 polished stainless steel	40
5441S	Sliding T-shaped grab bar Ø32 1160x500 satin polished st.st.	105	710500	Wall mounted soap dish Bayblend® chrome plated matt	35
5460N	Straight bar Ø32 +sliding block H1150 white Nylon	132	710501	Wall mounted soap dish Bayblend® chrome plated bright	35
5460P2	Straight bar Ø32 +sliding block H1150 polished st steel	100	729008	Soap dispenser straight spout 1L bottle, chromed brass	33
5460S	Straight bar Ø32 +sliding block H1150 st steel satin finish	100	729012	Soap dispenser curved spout 1L bottle, chromed brass	33
5465P2	Replaced by 5460P2	-	729108	Soap dispenser straight spout, tube L1200, chromed brass	33
5481DP2	Grab bar and shower rail (right) Ø32 polished st steel	106	729112	Soap dispenser curved spout, tube L1200, chromed brass	33
5481DS	Grab bar and shower rail (right) Ø32 stainless steel satin	106	729150	Wall mounted soap dispenser cross wall 180, chromed	33
5481GP2	Grab bar and shower rail (left) Ø32 polished stainless steel	106	729302	Maintenance kit for soap dispenser type 729150/729012	-
5481GS	Grab bar and shower rail (left) Ø32 stainless steel satin	106	729303	Cartridge for soap dispenser type 729150/729200	-
5481N	Shower grab bar and sliding white nylon vert. bar Ø32	139	729308	Cartridge for soap dispenser type 729008	-
5481P	Grab bar and sliding vert. bar Ø32 bright stainless steel	107	729312	Cartridge for soap dispenser type 729012	-
5481S	Grab bar and sliding vert. bar Ø32 satin stainless steel	107	729508	Soap dispenser straight spout 0.5L bottle, chromed brass	33
5490DP2	Replaced by 5481DP2	-	729512	Soap dispenser curved spout 0.5L bottle, chromed brass	33
5490DS	Replaced by 5481DS	-	813	5 jet shower head M1/2" chrome Ø100, scale resistant	-
5490GP2	Replaced by 5481GP2	-	815	Single jet shower head M1/2" Ø100, scale resistant	74
5490GS	Replaced by 5481GS	-	830	Shower head retaining collar for bars Ø 19-35mm	74
5490N	Handrail & grab bar for shower seat Ø32 white Nylon	138	836T1	Reinforced PVC SILVER flexible shower hose L1.5m	74
550	ECO grab rail 135° Ø25 220x220 polished stainless steel	158	836T3	Reinforced PVC SILVER flexible shower hose L0.85m	74
551	Wall shelf 120x450 polished stainless steel	40	CPP32P	Solid cover plate Ø72 UltraPolish polished stainless steel	112

References prefixed by * are available while stocks last. References are listed in ascending alphanumerical order.

REF.	DESCRIPTION	P.	REF.	DESCRIPTION	P.
CPP32S	Solid cover plate Ø72 UltraSatin stainless steel satin	112	DOCMREC1	DOC M Recessed shower pack white epoxy coated	162
DOCMEXP1	DOC M Exposed shower pack white epoxy coated	163	DOCMREC2	DOC M Recessed shower pack blue epoxy coated	162
DOCMEXP2	DOC M Exposed shower pack blue epoxy coated	163			

References prefixed by * are available while stocks last. References are listed in ascending alphanumerical order.

The general terms and conditions are valid for all customers.

ORDERS AND QUOTATIONS:

These will be processed in order of receipt. All orders sent imply acceptance of our general terms and conditions of sale and customers waive any claims that may arise from clauses in their own documentation which may differ.

The customer agrees to these terms from the moment that we receive their order, which cannot be cancelled. Orders are accepted without obligation to deliver the order in full in one delivery.

Our commercial representatives are not authorised to agree additional terms verbally, or to provide verbal guarantees beyond those provided in the written contract. In the event of default or delayed payment, the Company will be entitled to suspend deliveries or cancel existing orders without any claim for damages from the customer. In the event of a change in circumstances of the buyer, we reserve the right to cancel existing orders or to demand payment guarantees.

Our quotes do not amount to specifications; specifiers and professional installers are solely responsible for the choice of products according to their intended use, current regulations and recommended guidelines.

PRICE:

Deliveries are invoiced according to the conditions in place at the date of despatch. Prices are given without guarantee and they may be changed without notice subject to fluctuations in costs, VAT or other taxes, according to the prevailing economic conditions.

Price increases will be announced one month prior to their application, and they apply to quotes and orders in hand.

PAYMENTS:

Terms of payments are confirmed when an account is opened, and are dependent on the terms of our credit insurance, and according to each country. We do not give discount for early payment.

In accordance with Article L441-6 of the Commercial Code, any delay in payment will give rise to the following from the first day of delay, regardless of their status with the supplier:

- An interest rate for delayed payment will be applied, equal to the European Central Bank refinancing rate plus 10% (French Law of Modernization of the Economy - LME - No. 2008-776 of 4th August 2008);
- A one-off payment of 40 Euros will apply to cover expenses (European Directive 2011/7 of 16th February 2011, Law 2012-387 of 22nd March 2012, and Decree 2012-1115 of 2nd October, 2012);
- When the recovery costs exceed the amount of the one-off payment, additional compensation will apply where justified.

In the case of late payment, a one-off payment may be required, replacing existing conditions. We will not accept any set off, only our assets have a legal value.

DELIVERY TIMES:

Despatch dates are indicative only and we shall not be liable for any delay or failure in carrying out our obligations where the delay or failure to deliver is caused by risks of manufacturing or where the cause is beyond our control. Delivery delay will not give rise to compensation payment or goods rejection.

SHIPPING:

Orders are sent to our distributors. We do not deliver to site. The buyer assumes responsibility for carriage and packing costs unless otherwise stated in the Incoterms on the invoice accompanying the goods. The goods are always forwarded at the buyer's own risk, whatever the method of transport, even if the carriage is free and special conditions have been granted. The carrier is solely responsible for their delivery, and in the event of delay, missing items, damage or other dispute, the customer must indicate this via the delivery driver's paperwork (either electronically or in hard copy) AND follow up with written notification sent by recorded delivery within 24 hours. A copy of this letter must be addressed to us.

CLAIMS:

No claim will be allowed where the delay in reporting exceeds 8 days following receipt of the goods. The whole of the delivery cannot be rejected because of partial damages and shortages.

PROPERTY IN GOODS:

Notwithstanding any agreed terms of sale, the goods shall remain the property of the seller until payment is made in full. The failure to meet a payment deadline may result in the reclamation of these goods.

The buyer assumes the risks of loss or damage, regardless of the means of delivery, as described in 'DELIVERY TIMES' and 'SHIPPING' above, as well as liability for the damage they might cause.

WARRANTY AND RESPONSIBILITY:

Our products are warrantied against any manufacturing defect for a period of 10 years, including electronic controls, excluding other electrical accessories (e.g. hand dryers, etc.) which have a 3-year warranty from the invoice date. This does not apply to products with an expiry date. This warranty is limited to replacement or repair of defective components as determined by our workshops in France but excludes the costs of spoilage, handling and carriage or compensation whatever they are. We are not responsible for handling charges and the cost of returning products to our workshops.

Disasters or major water damage as a result of manufacturing defects are covered by our product and/or public liability insurance.

Our warranty and responsibility does not include the following:

- installation that does not comply with the technical specification or current recommended guidelines;
- worn parts;
- non-compliance with installation, user and maintenance guides;
- other factors independent of our products' quality, for example: detergents or abrasive cleaning products, the action of hard water, foreign bodies (e.g. gravel, sand, iron filings, scale, etc.), chemical and electrolytic phenomenon;
- lack of supervision, poor storage or poor maintenance;
- product modifications or actions by the customer, or a third party, without our authorisation using non-DELABIE components and/or consumable items.
- products past their expiry date.

The water-tightness of connections, joints and the product housing is the responsibility of the professional responsible for installation, and must be guaranteed by them. Warranty excludes joints, valves, washers and rubber seals. However they would be supplied if the warranty application requires them. Any finishes other than chrome or nickel are also excluded from the warranty. In the event that the product has been discontinued or manufacturing methods have changed and replacements are not available, similar alternative products will be offered. Replacement under warranty will not extend the duration of the original warranty.

Legal warranty of latent defects applies in any event.

SPARE PARTS:

Spare parts and mechanisms that are essential to ensure the correct operation of our products will be held in stock for the duration of the guarantee. They are listed at the back of our catalogues.

RETURNS:

Goods may not be returned to us for credit without our prior written approval obtained by the buyer from the Company and they are received in a good state (determined by our goods inwards department). All transportation costs for returned goods must be paid by the buyer. Goods must be returned to our factory* with good protective packaging. Deliveries less than a month old will be refunded at the invoiced price. For deliveries older than one month, a deduction will be made for checking, handling and administration costs. A repair and re-stocking fee will apply where appropriate.

Product returns are not permitted in the following circumstances: discontinued products, specially manufactured products, technical or aesthetic evolution of the product since the date of purchase, scratched or damaged products, products purchased more than one year previously, products with an expiry date. If sent to DELABIE, those products outside the scope of returns will be immediately destroyed/recycled, and will not be returned to the customer.

The schedule of standard deductions is as follows:

- return less than 1 month: refund at invoiced price
- return between 1 and 3 months: deduction of 15%
- return between 3 months and 1 year: deduction of 30%
- return after 1 year: no refund possible.
- return without prior agreement: additional deduction of 5% of the value of the goods with a minimum value of €50 excl. VAT.

* DELABIE S.C.S.
18, rue du Maréchal Foch
80130 Friville Escarbotin – FRANCE

CLEANING - MAINTENANCE:

Clean with slightly soapy water only, using a soft cloth or sponge, rinse and dry thoroughly. Do not use abrasive or chlorine-based products (with a hydrochloric acid base), or dyes.

PHOTOGRAPHS AND DRAWINGS:

All photos, drawings or illustrations are for illustrative purposes only, without contractual obligation, and may be subject to change without notice.

We reserve the right to modify designs and dimensions without notice and without recourse. This applies to all references, dimensions, information contained in various documents, catalogues, installation guides, price lists and websites, which can be modified or discontinued at any time without notice.

INTELLECTUAL PROPERTY AND USE OF CONTENT:

The content (including but not limited to the information, text, graphics, data, images, photos, visuals, videos and soundtrack, and the format of all these elements and our catalogues, websites, etc.) are protected under copyright and/or other intellectual property. The contents are the sole property of their respective editors. Any copying, reproduction, use, adaptation, alteration, modification, translation, dissemination, complete or partial, of content, whether they belong to DELABIE or a third party which has granted the rights to DELABIE, by any means whatsoever, is illegal except for the limiting rights that are granted below, and/or private copying for the exclusive use of the copier. The content presented in our communication and business tools may be subject to change without notice and are provided without warranty of any kind, express or implied, and cannot give rise to any right to compensation. Protected content may be specifically identified by the following copyright notices: © or "All rights reserved".

The names and logos appearing in our catalogues and websites are registered trademarks. These distinctive marks are the exclusive property of DELABIE or third parties who have granted the rights to DELABIE. Any use, complete or partial reproduction, or imitation of these marks is prohibited without prior express consent of DELABIE.

Alteration and modification of the contents or their use for any purpose other than that authorised, constitute an infringement of DELABIE's, or a third party's, property rights. With the following limitations, DELABIE grants you the right to download and distribute the content

- where the download function exists
- for non-commercial purposes
- in good faith
- for maintaining the proprietary notices intact, and for the publication or posting of existing content online, if such information is stated. This right should in no way be interpreted as a trademark or copyright license for the aforementioned content.

PERSONAL DATA PROTECTION:

In line with the General Data Protection Regulation (GDPR), DELABIE is doing everything necessary to limit to a bare minimum the collection of personal data, and its conservation and ensure its protection.

DELABIE only uses this data for its own use for purposes of information and commercialisation of its products. It is not, under any circumstances, given to third parties.

The right of access, rectification, removal and opposition to the processing in addition to the limitation and transferability of your data is possible on request to our Data Protection Officer (DPO) at DELABIE via email (dpo@delabie.fr) or recorded delivery with a photocopy of a photo ID to the following address: DELABIE, 18 rue du Maréchal Foch, 80130 FRIVILLE, France.

EXCLUSIVE TERRITORIES:

In most countries throughout the world, our company has entered into exclusive agreements with organisations to import and distribute our products. Within this framework, our clients cannot sell our products outside their national borders without an express prior agreement on our part.

JURISDICTION:

Acceptance of an order delivered from France settles the contract under the French law. All disputes arising from the present contract will be settled definitively by the Court located in the area of our domicile, even in the event of multiple defendants, regardless of the delivery location or stipulated payment. All clauses to the contrary will be considered null by the mere fact of having dealt with our company.

AVAILABLE CATALOGUES:

DOC 609INT: Water Controls for Public and Commercial Places

DOC 950INT: Accessibility and Independence - Hygienic Accessories for Public and Commercial Places

DOC 900INT: Water Controls for Healthcare Facilities and Retirement Homes

DOC 750INT: Stainless Steel Sanitary Ware

DOC 200INT: Water Controls for Professional Catering

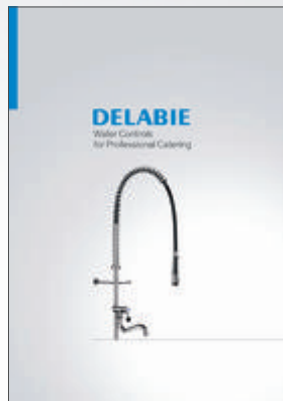
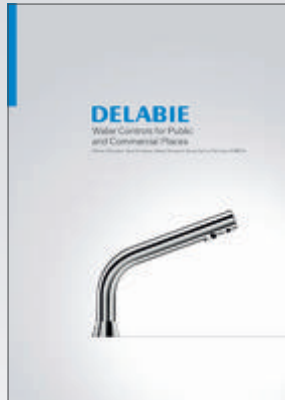

DELABIE

18, rue du Maréchal Foch
80130 FRIVILLE - FRANCE

DELABIE S.C.S., share capital 1.000.000 € - RCS 615 680 089 Amiens

delabie.com



PEFC 10-32-3010 / Certifié PEFC

DOC 950INT - 04/2019