

COMMERCIAL

DRAINAGE

SOLUTIONS



Dynamic Building Material Co., Ltd.

Unit B3, Block B, 19/F

Kailey Industrial Centre

12 Fung Yip Street

Chai Wan, Hong Kong

Tel: (852) 2838 0692

Fax: (852) 2116 0378

Email: info@dynamichk.com

www.dbmhc.com

**PRODUCT
SERIES**

PONTINI®



**INNOVATIVE
DRAINAGE
SOLUTIONS**

COMMERCIAL & INDUSTRIAL DRAINAGE SYSTEM

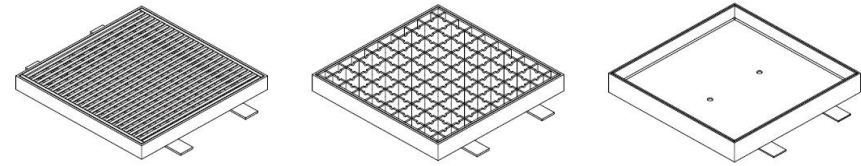

Grate With Frame Base

Item No.	Size
HW&FRC	250*250*25mm / 300*300*25mm / Customized
GM&FRC	250*250*25mm / 300*300*25mm / Customized
TL&FRC	250*250*25mm / 300*300*25mm / Customized

- Material: Stainless steel Grade 304/316
- Finish: Brushed
- Color: Stainless
- Grate Pattern: Tile Insert / Wedge Wire Grate / Mesh
- Frame: 25*25*25mm (90 Angle Bar)

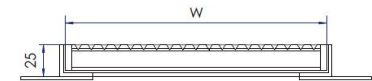
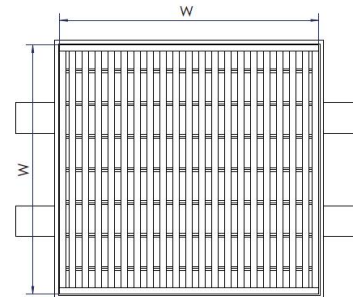

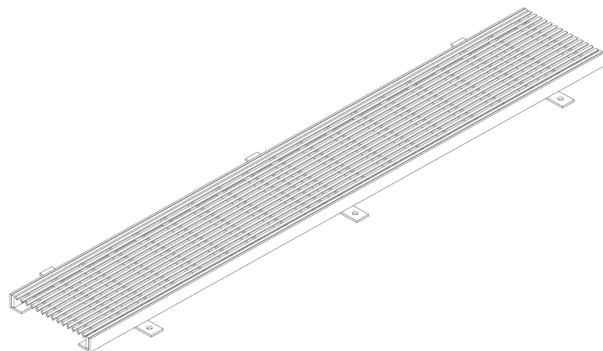

Wedge Wire Grate With Frame Base Channel

Item No.	Size (W * L)
HW05W150FRC	150*1000/3000mm
HW05W250FRC	250*1000/3000mm
HW05W300FRC	300*1000/3000mm

Material: Stainless steel Grade 304/316
 Finish: Satin
 Loading Class: Light Duty
 Application: Pathways , pedestrain areas and comparable surfaces e.g.parks , car parks and car parking decks

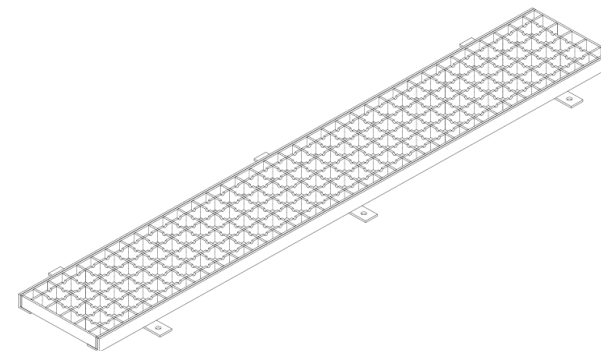
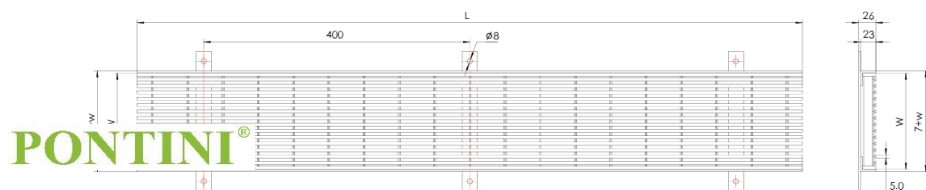

Mesh Grate With Frame Base Channel

Item No.	Size (W * L)
GM03W150FRC	150*1000/3000mm
GM03W250FRC	250*1000/3000mm
GM03W300FRC	300*1000/3000mm

Material: Stainless steel Grade 304/316
 Finish: Satin
 Loading Class: Light Duty
 Application: Pathways , pedestrain areas and comparable surfaces e.g.parks , car parks and car parking decks

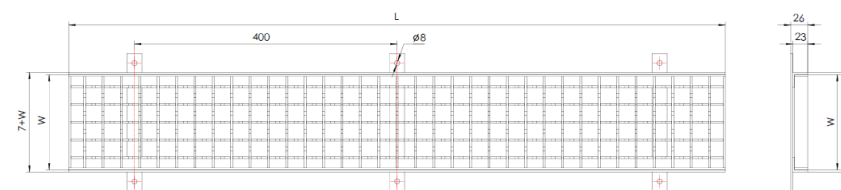

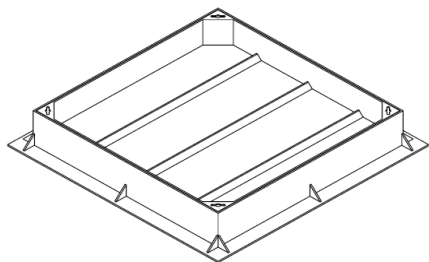

Double Seal Accessed Manhole Cover

Item No.	Clear Opening	Depth
MHD-600	600*600mm	125mm
MHD-800	800*800mm	125mm
MHD-900	900*900mm	125mm

Material: Stainless steel Grade 304/316
 Finish: Satin
 Loading Class: Light Duty
 Application: Pathways , pedestrain areas and comparable surfances
 e.g.parks , car parks and car parking decks

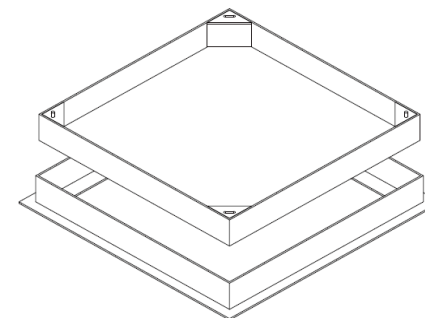

Recessed Manhole Cover

Item No.	Clear Opening	Depth
MHA-600	600*600mm	90mm
MHA-800	800*800mm	90mm
MHA-900	900*900mm	90mm

Material: Stainless steel Grade 304/316
 Finish: Satin
 Loading Class: Light Duty
 Application: Pathways , pedestrain areas and comparable surfances
 e.g.parks , car parks and car parking decks

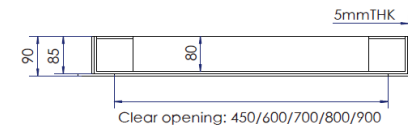
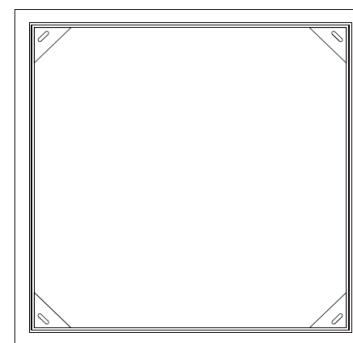
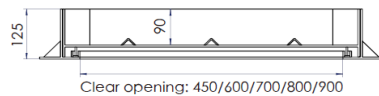
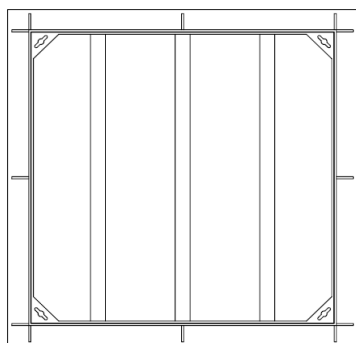

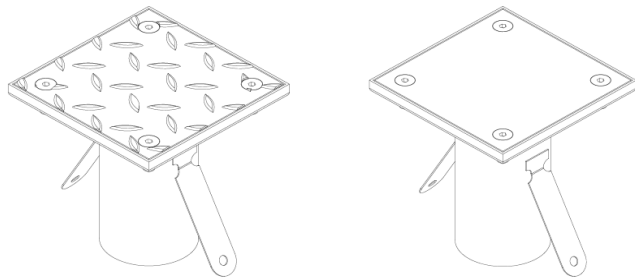

Floor Clean Out

Item No.	Grate Style	Size	Outlet
CFH-150A	Anti	150*150*148.5mm	75 mm
CFH-150S	Smooth	150*150*148.5mm	75 mm

Material: Stainless steel Grade 304/316
 Finish: Polish / Satin / Electric Polished
 Loading Class: Light Duty
 Application: Pathways , pedestrain areas and comparable surfances
 e.g.parks , car parks and car parking decks

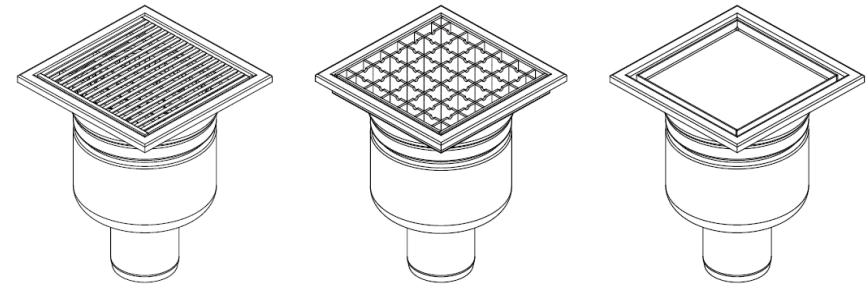
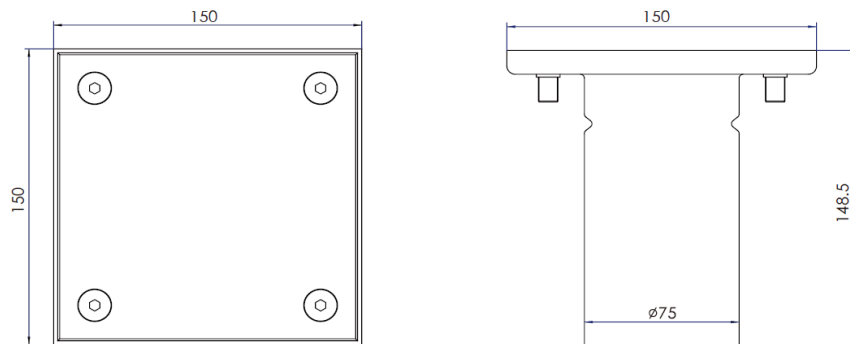

Trash Box

Item No.	Size	Outlet
TBS200	200*200*268mm	75 /100mm
TBS250	250*250*268mm	75 /100mm

Material: Stainless steel Grade 304/316
 Finish: Polish / Satin / Electric Polished
 Color: Stainless
 Grate Pattern: Tile Insert / Wedge Wire Grate / Anti-sliding Grate
 Ladder Grate / Mesh Grate for option
 (see page 16)
 Application: Pathways , pedestrain areas and comparable surfances
 e.g.parks , car parks and car parking decks

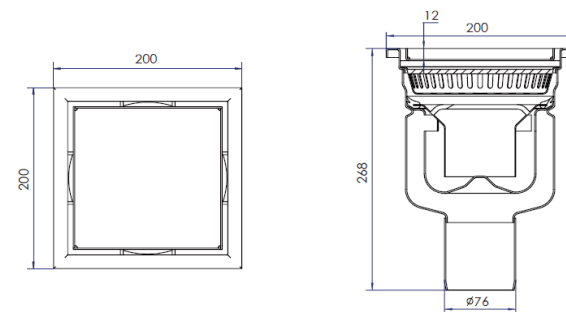

DRAINAGE SYSTEM

The type of drainage finds application of swimming pool, food processing plants (breweries, dairy plants, slaughterhouses), chemical plants, restaurants, hospitals, and the like.

They are also used in the facilities, where the sanitary regulations and technological process necessitate making the stainless steel drainage, due to high hygienic requirements.

Customised solutions upon request

- Customised channel widths
- Material grade 316
- Made to Measure

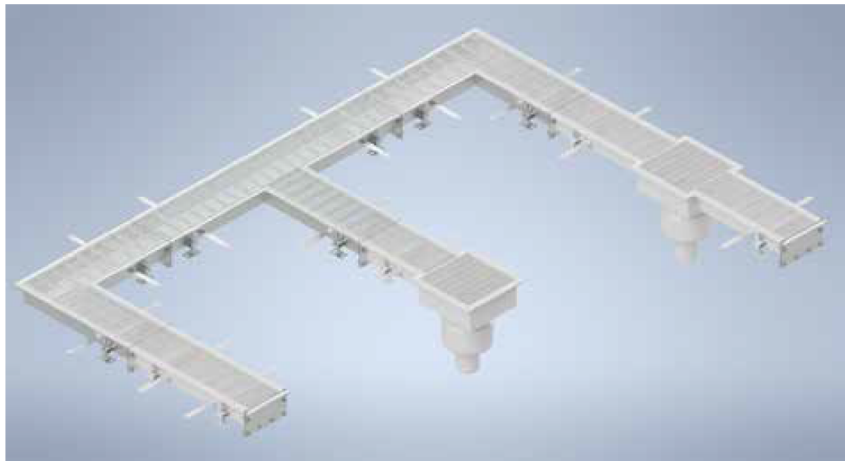

- Material: Stainless steel Grade 304/316
- Finish: Polish / Satin / Electric Polished
- Color: Stainless
- Special: Flanges connected with Rubber Seal to avoid leak

SS200X Series

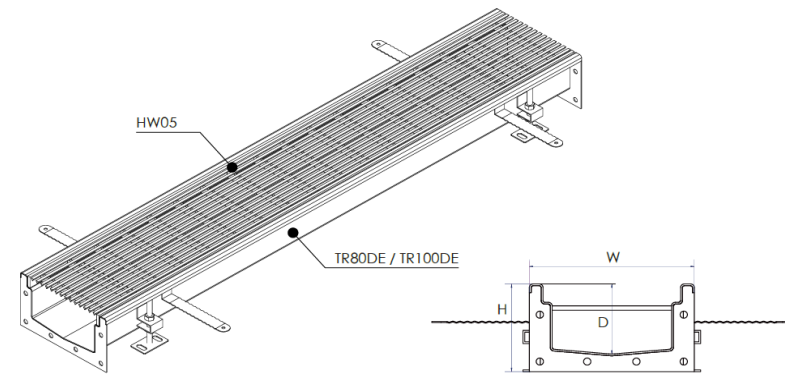

Linear-SS2001

Item No.	W * H	L	Depth
TR80DE	181*100mm	1000/1500/2000mm	80mm
TR100DE	181*120mm	1000/1500/2000mm	100mm
TR100/120DE	181*120/140mm	1000/1500/2000mm	100/120mm

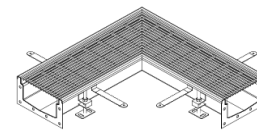

Corner-S2002

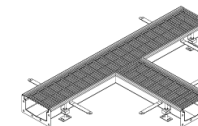

Branch-S2003

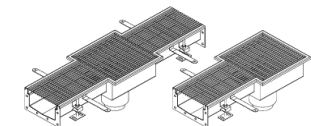

Trash Box-S2004

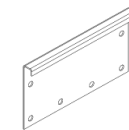

End Cap-S2005

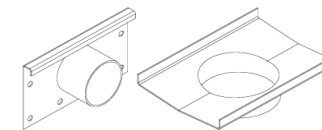

Outlet-S2006



Gasket

DRAINAGE CHANNEL CHANNEL EDGE FINISHING

The edge finishing should depend on the flooring and water temperature.
We can offer the following options:

Flat base channels

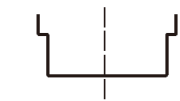

1-with Straight Edge
(ST)



2-with Outer Folded Edge (Standard)
(FO)



3-with Downward Edge
(DE)



4-with Tiling Flange
(TF)



5-with Wall Flange
(WF)

“ V ” base channels

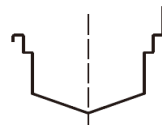
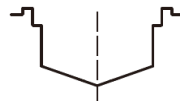
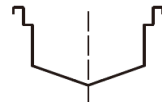
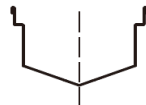
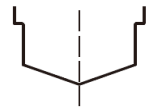

Application

The type of drainage finds application of swimming pool, food processing plants (breweries, dairy plants, slaughterhouses), chemical plants, restaurants, hospitals, and the like. They are also used in the facilities, where the sanitary regulations and technological process necessitate making the stainless steel drainage, due to high hygienic requirements

GRATE STYLE

Grate

Available Length

Wedge Wire Grate-HW03 / HW05 / HW08



H:20mm

L:500/1000/1500mm

Anti-sliding Grate-HW05S

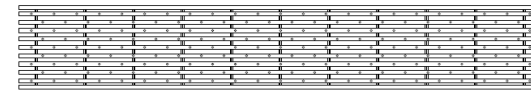

H:20mm

L:500/1000/1500mm

Ladder Grate-GL

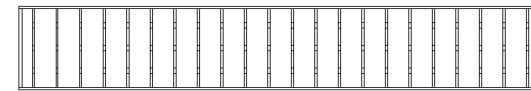

H:25mm

L:500/1000/1500mm

Mesh Grate-GM

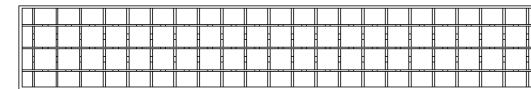

H:25mm

L:500/1000/1500mm

* Customised design is available, pls provide the details or drawing.



SLOTTED SYSTEM

Slotted channels are supplied ex-works in lengths of 1000 mm/section. It is designed to be connected with flange and screws. Rubber seal is used to avoid the leak.

Typical Applications: Industrial kitchens in canteens, hospitals, care homes, businesses, catering companies, pubs, restaurants, fast food outlets, cafeterias, abattoirs and meat-processing industry, butcher's, drink industry, pharmaceutical industry, cosmetics industry, swimming pools and leisure industry .

- Customised solutions upon request
- Customised channel widths
 - Material grade 304/316
 - Extra-flat models

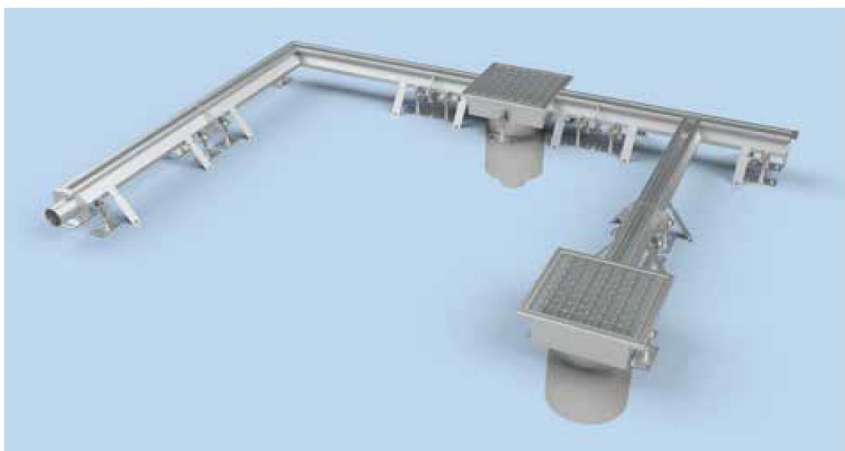

SS400X Series

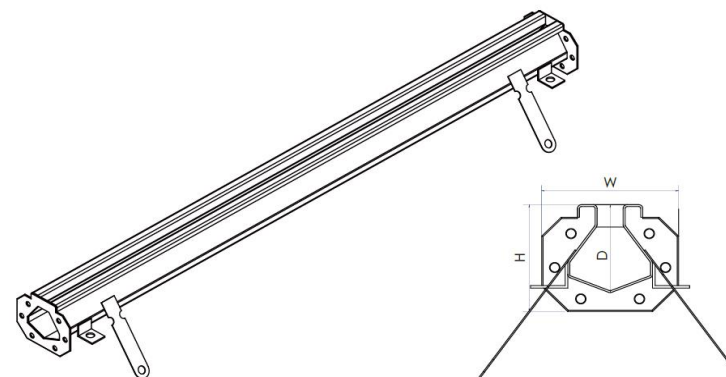

Linear-SS4001

Item No.	W * H	L	Depth
SS4001	105*85mm	500~1800mm	70mm
SS4001	120*150mm	500~1800mm	135mm

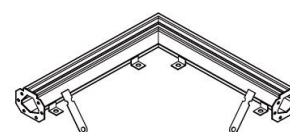

Branch-SS4002

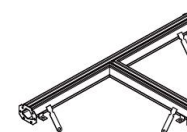

Corner-SS4003

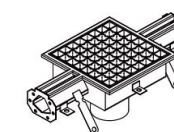

Trash Box-SS4004

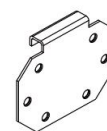

End Cap-SS4005

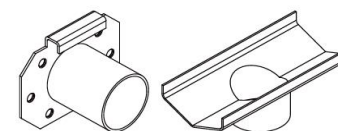

Outlet-SS4006



Silicon Seal

PVC GUTTER



The PVC channel is designed for the demand for economic but effective surface drainage system. It is developed for the safe and attractive drainage of patios, driveways, and other paved surfaces.

Typical Applications

- Garages
- Patios
- Driveways
- Pedestrian Area

PL300X Series



Linear-PL3001 / PL3002

Item No.	Grate	Base	W * H * L	Loading Class
PL3001	PP	PP	125*80*1000mm	A15
PL3002	Galvanized	PP	125*80*1000mm	A15



End Cap-PL3003



Leaf Guard-PL3005

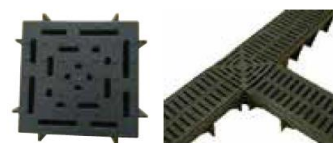

Square Hub-PL3004



Outlet-PL3006



HDPE Drainage Channel System

Slotted channels are supplied ex-works in lengths of 1000 mm/section. It is designed to be connected with flange and screws. Rubber seal is used to avoid the leak.

Typical Applications: Industrial kitchens in canteens, hospitals, care homes, businesses, catering companies, pubs, restaurants, fast food outlets, cafeterias, abattoirs and meat-processing industry, butcher' s, drink industry, pharmaceutical industry, cosmetics industry, swimming pools and leisure industry .

Customised solutions upon request

- Customised channel widths
- Material grade 304/316
- Extra-flat models

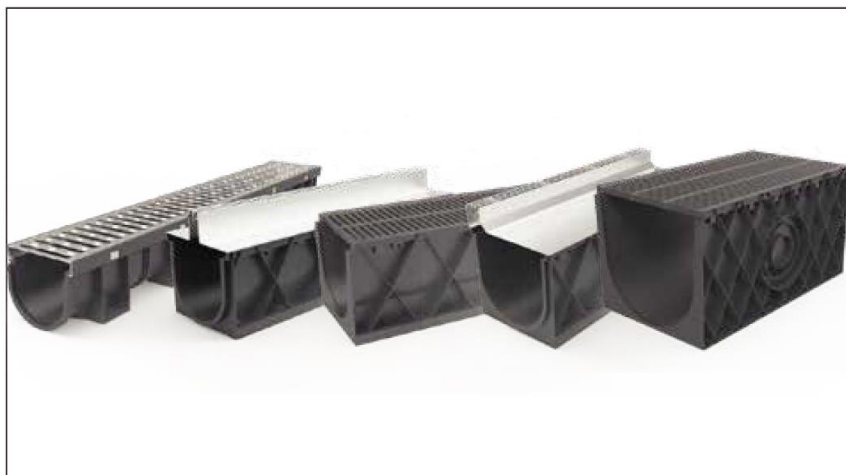

HDPE Linear Channel

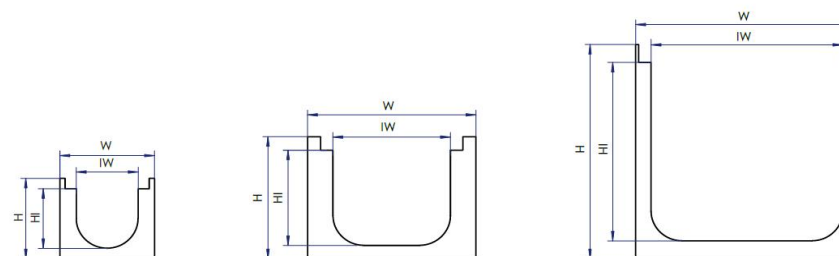

Item No.	IW * IH * IL	W * H * L
U100	100*45*1000mm	145*80*1000mm
	100*100*1000mm	150*130*1000mm
	100*150*1000mm	150*190*1000mm
U150	150*150*1000mm	215*195*1000mm
	200*200*1000mm	270*240*1000mm
U200	200*250*1000mm	250*300*1000mm
	250*250*1000mm	310*305*1000mm
U250	300*300*1000mm	360*360*1000mm
U300	400*400*1000mm	475*450*1000mm
U400	500*500*1000mm	575*550*1000mm

Grate Option



HDPE black grate



HDPE side slot with ss bar



HDPE iron grate

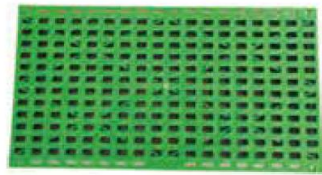

HDPE green mesh grate

Catch Basin

Low Profile Catch Basin with with Flexible Pipe 2"



Catch Basin Kit with Debris Basket and Grating



WEDGE WIRE GRATE

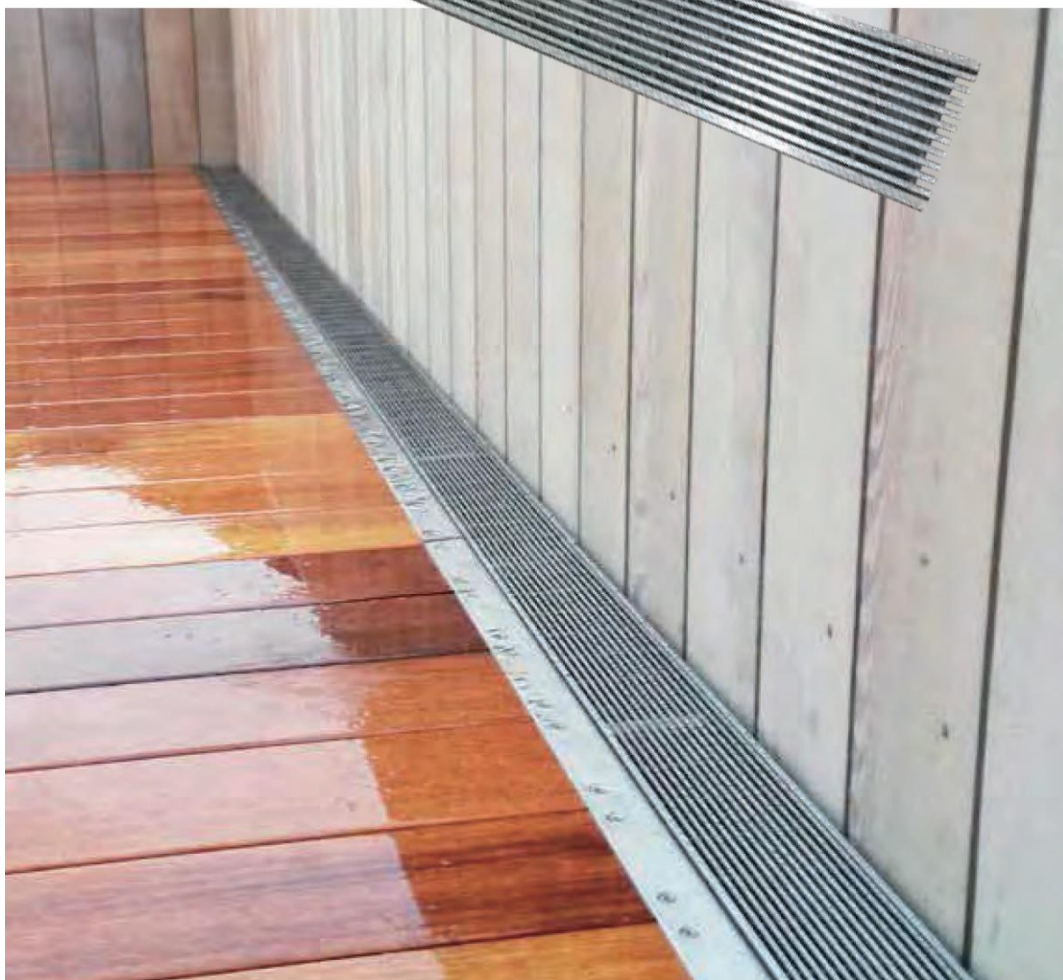

POLYMER CONCRET DRAIN

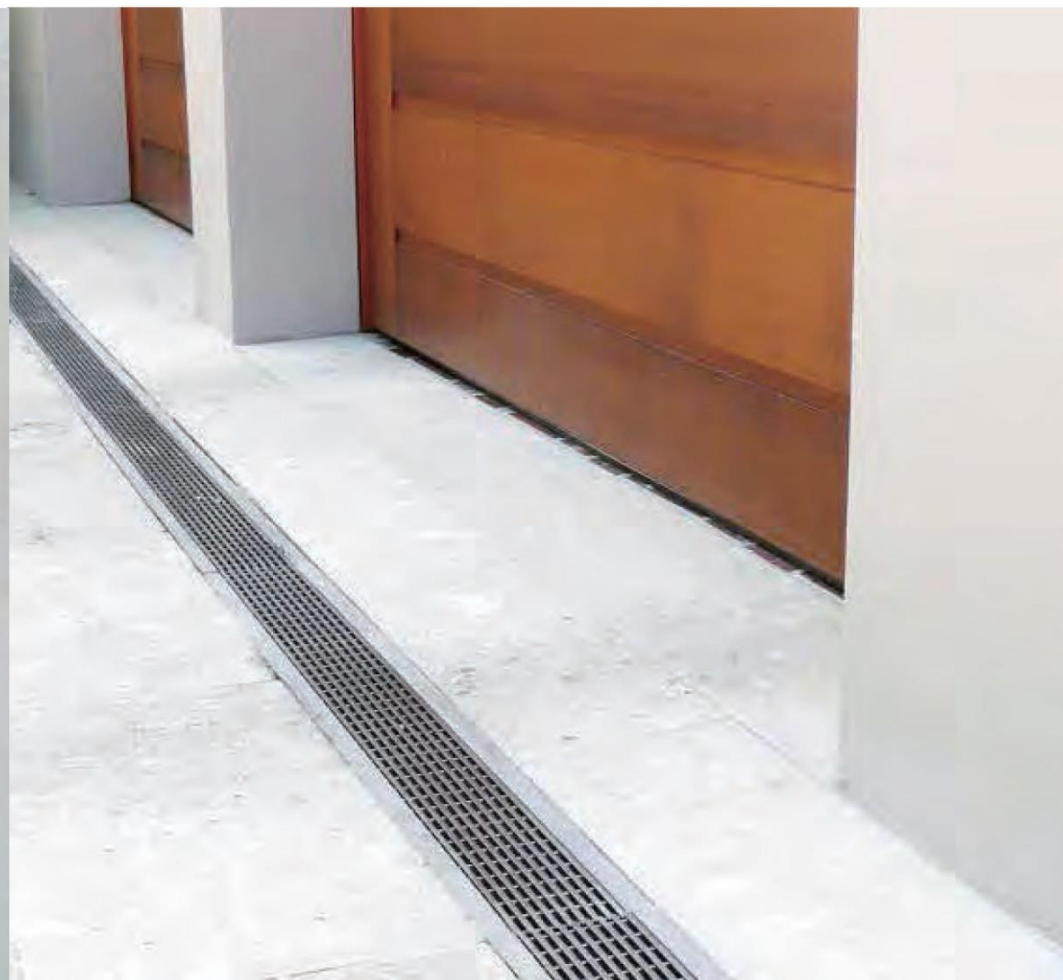

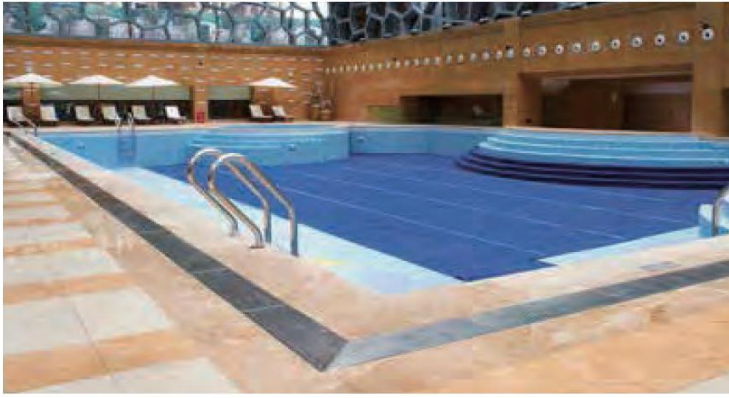

**INNOVATIVE
DRAINAGE
SOLUTIONS**

PONTINI®

SWIMMING POOL / BALCONY / SHOWER ROOM / BASIN / PUBLIC AREA